

Sestava Eminence Delta-15 + Selenium D220Ti + Selenium HM25-25

Osazení:

- Eminence DELTA-15 8/ohm

<http://eshop.prodance.cz/detailpage.asp?DPG=82362>

- Selenium D220Ti 8/ohm

<http://eshop.prodance.cz/detailpage.asp?DPG=90316>

- Selenium HM25-25

<http://eshop.prodance.cz/detailpage.asp?DPG=81673>

Schéma výhybky:

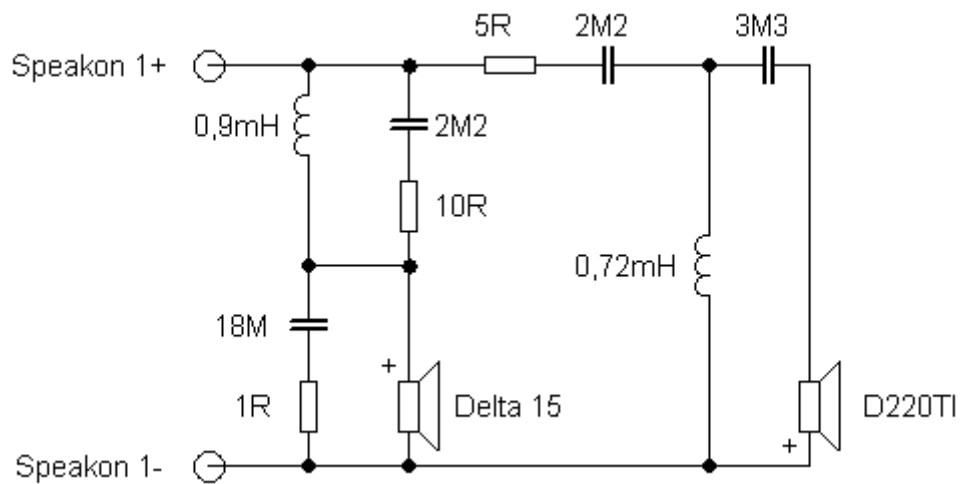

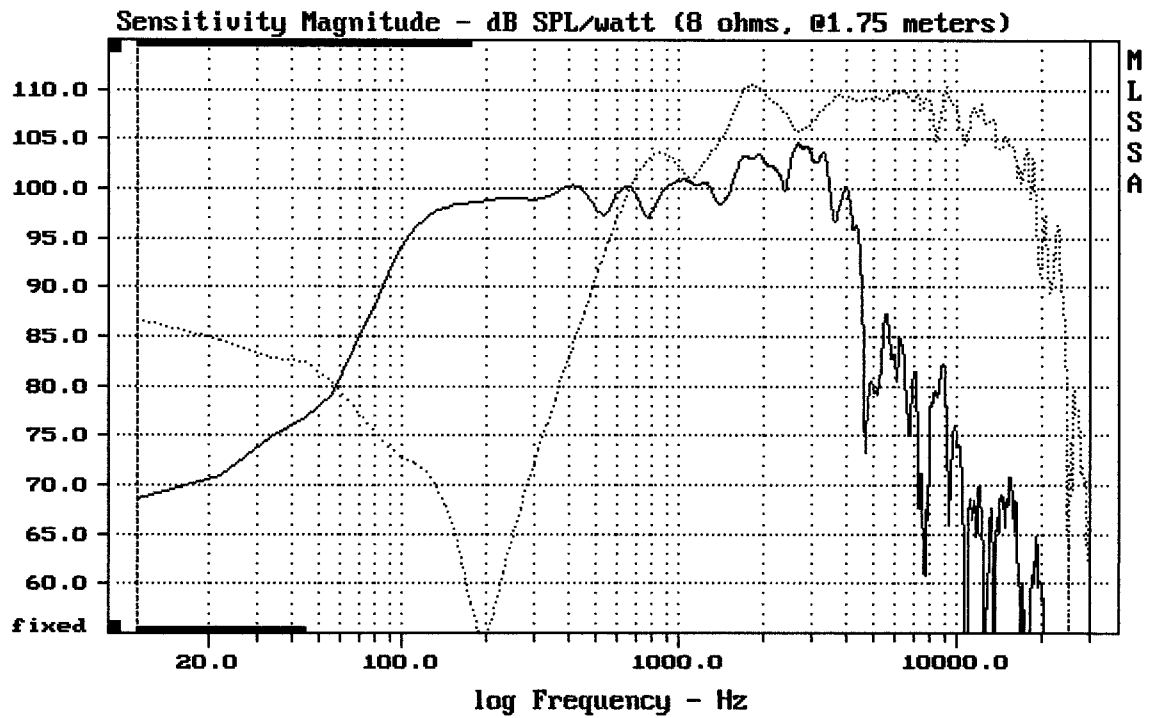

CURSOR: dy = 32.3107 x = 30007.1014 (2704)

DELTA15 + D220TI + HM25-25

MLSSA: Frequency Domain

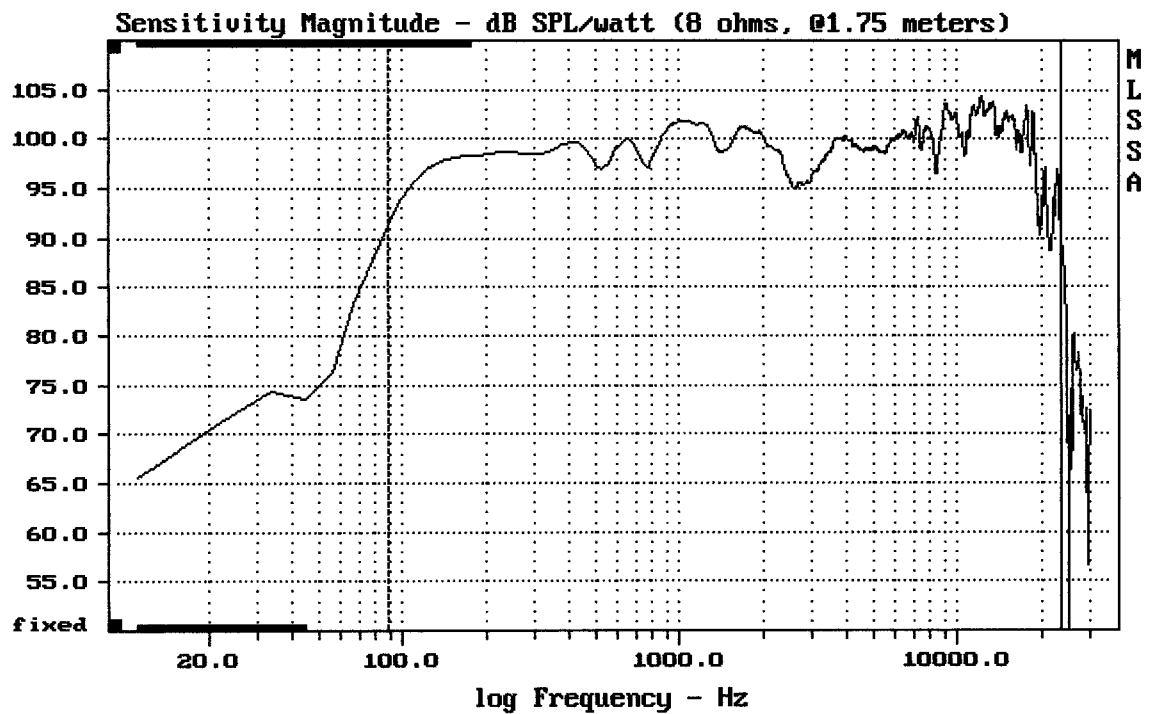

Level (89:23504 Hz) = 99.47 dB SPL/watt (8 ohms, @1.75 meters)

DELTA15 + D220TI + HM25-25

Výhybka pro D210Ti

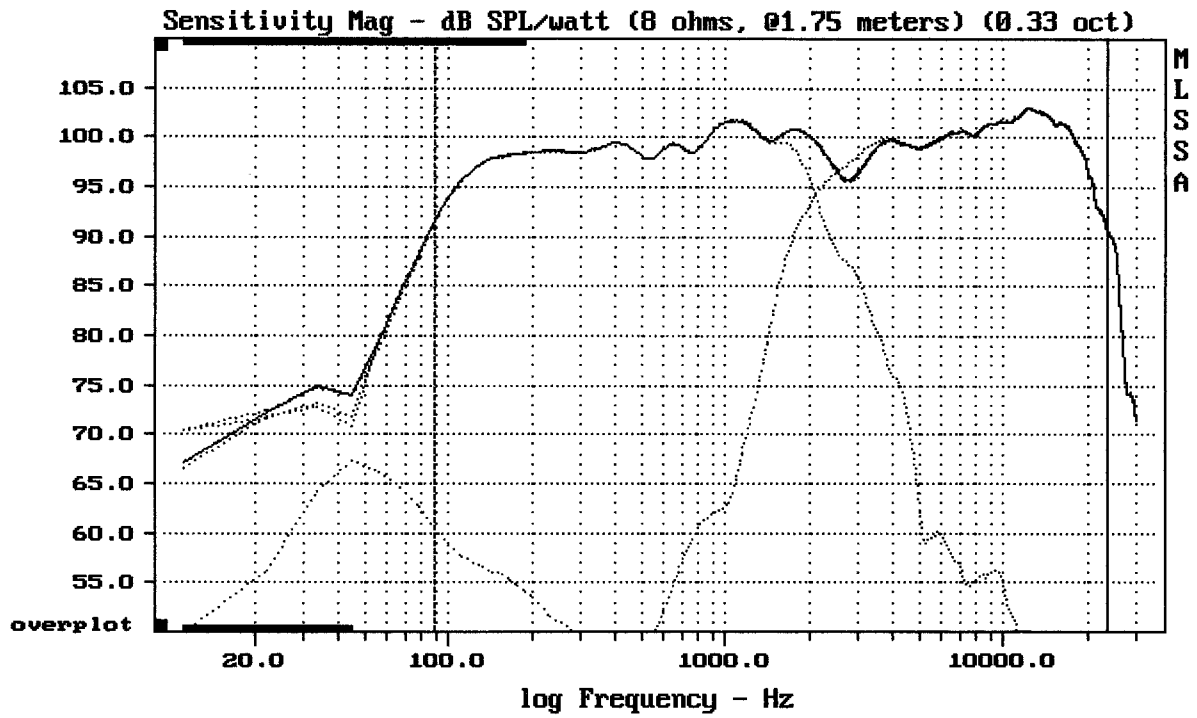

Level (89:23504 Hz) = 99.48 dB SPL/watt (8 ohms, @1.75 meters) (0.33 oct)

DELTA15 + D220TI + HM25-25

MLSSA: Frequency Domain

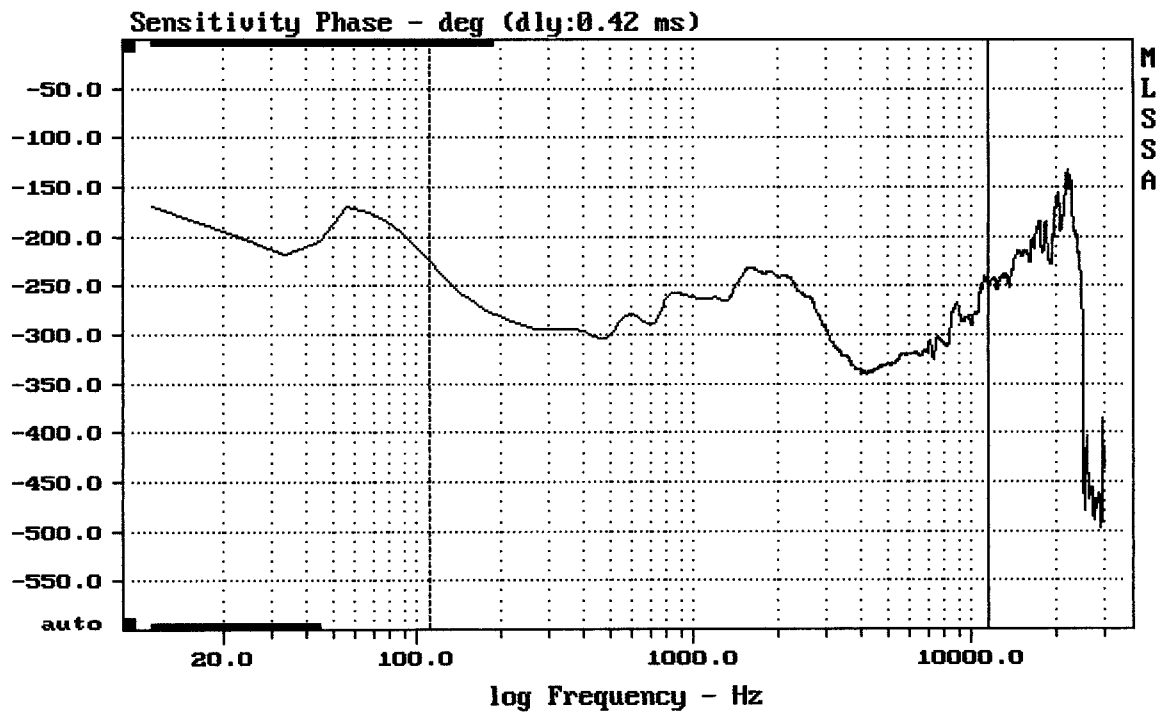

mean: -292.4, rms: 294.1, std: 31.13, max: -224.3, min: -340.3

DELTA15 + D220TI + HM25-25

Výhybka pro D210Ti

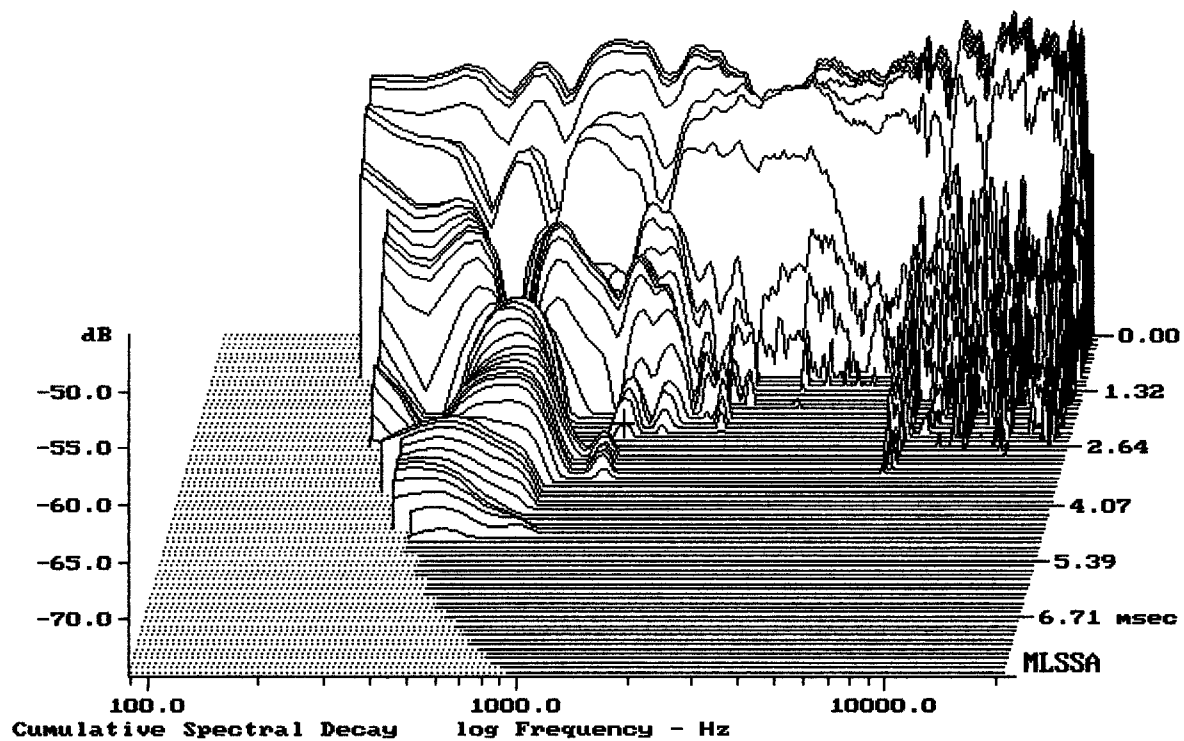

-73.75 dB, 1287 Hz (29), 2.420 msec (23)

DTTO

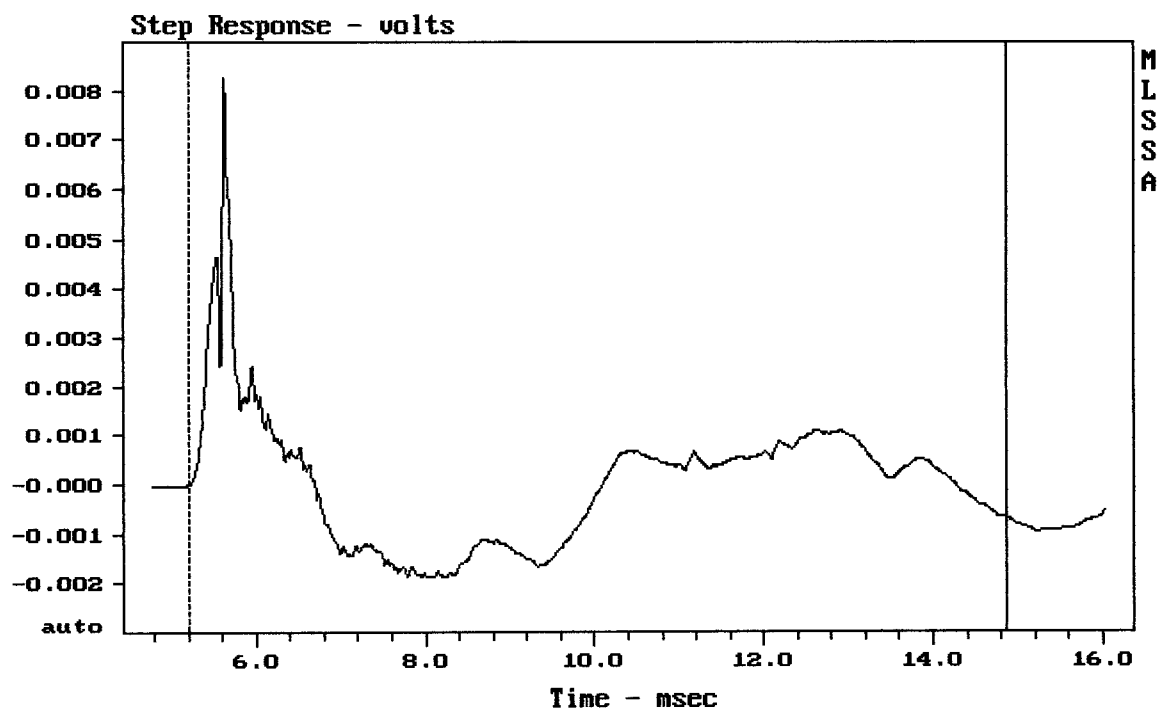

mean: 2.491e-005, rms: 0.001344, std: 0.001343, max: 0.008253, min: -0.001881

DELTA15 + D220T1 + HM25-25

Výhybka pro D210Ti

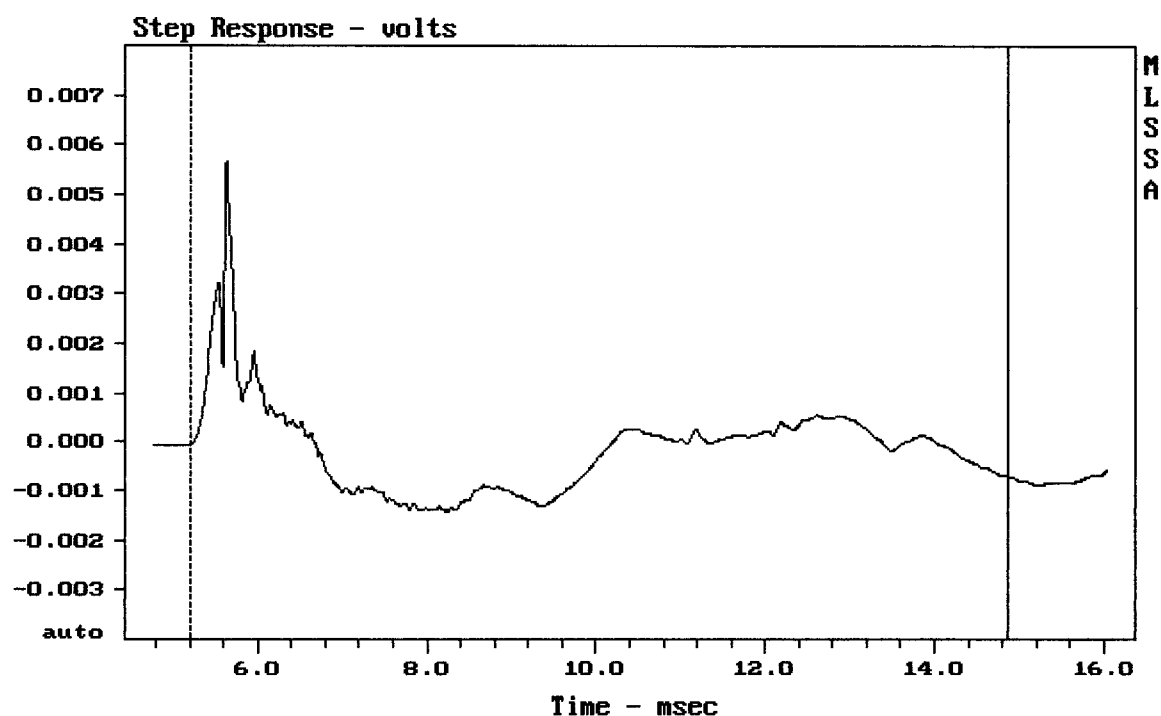

mean: -0.000149, rms: 0.0009492, std: 0.0009375, max: 0.005655, min: -0.001417

DELTA15 + D220TI + HM25-25

MLSSA: Time Domain

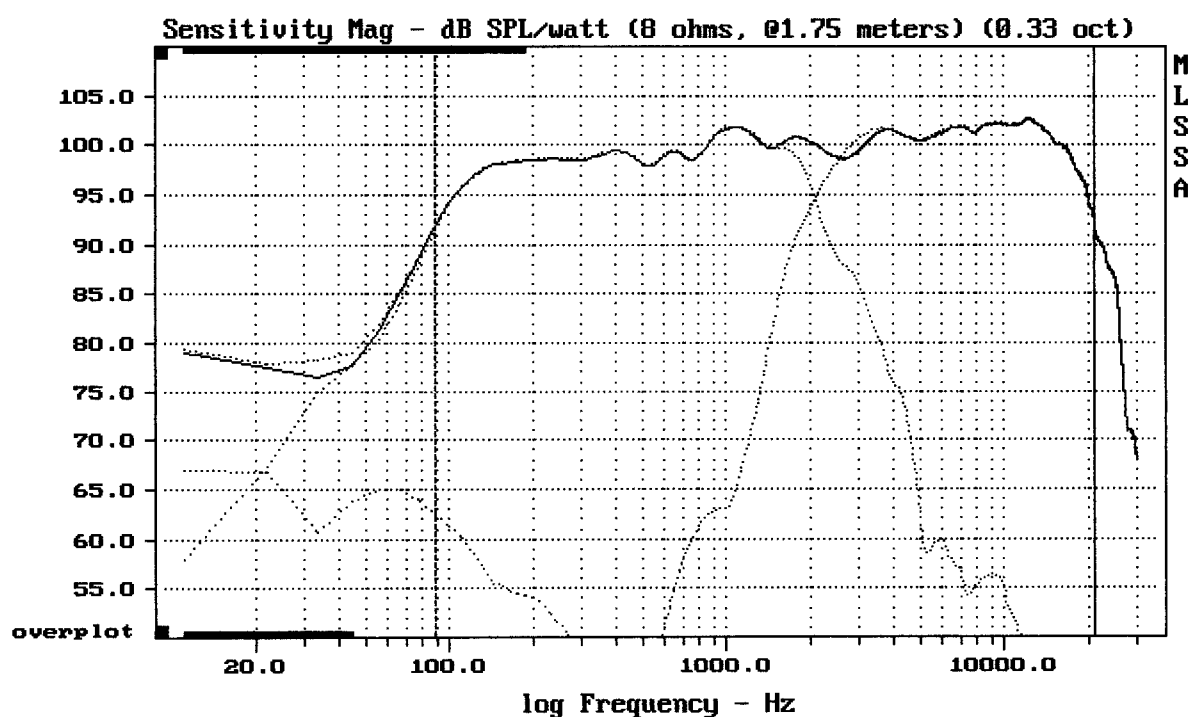

Level (89:21007 Hz) = 99.91 dB SPL/watt (8 ohms, @1.75 meters) (0.33 oct)

DELTA15 + D220TI + HM25-25

Výhybka ze schématu - D220Ti

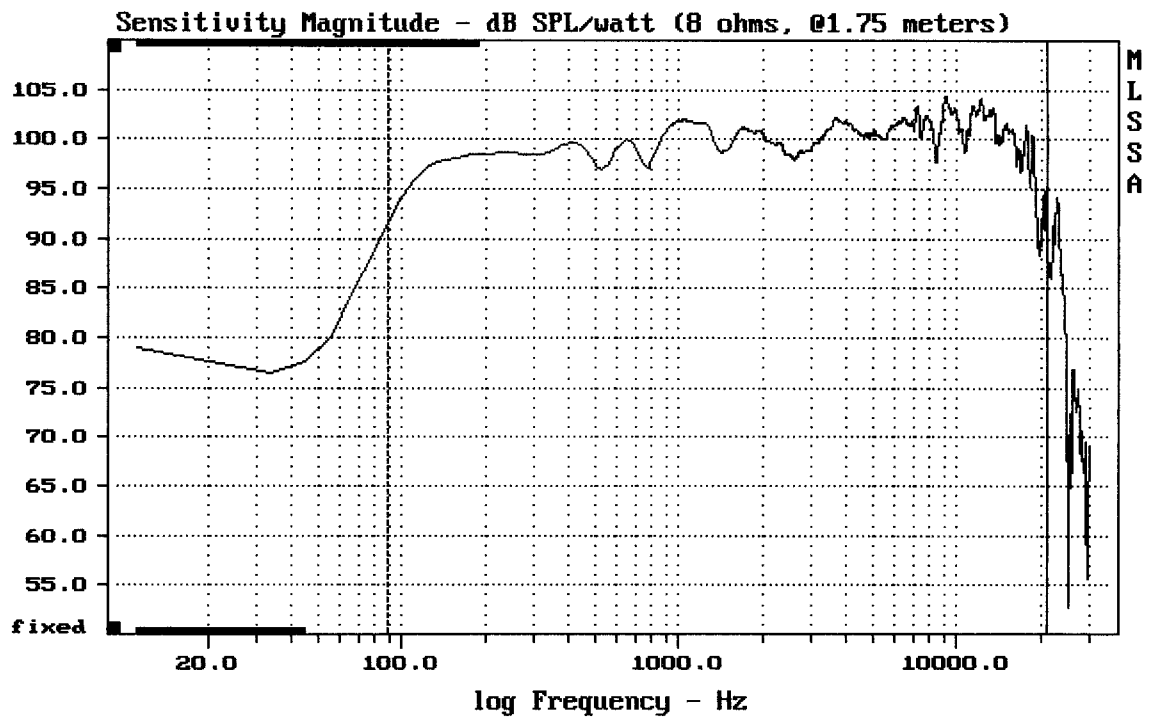

Level (89:21007 Hz) = 99.90 dB SPL/watt (8 ohms, @1.75 meters)

DELTA15 + D220TI + HM25-25

MLSSA: Frequency Domain

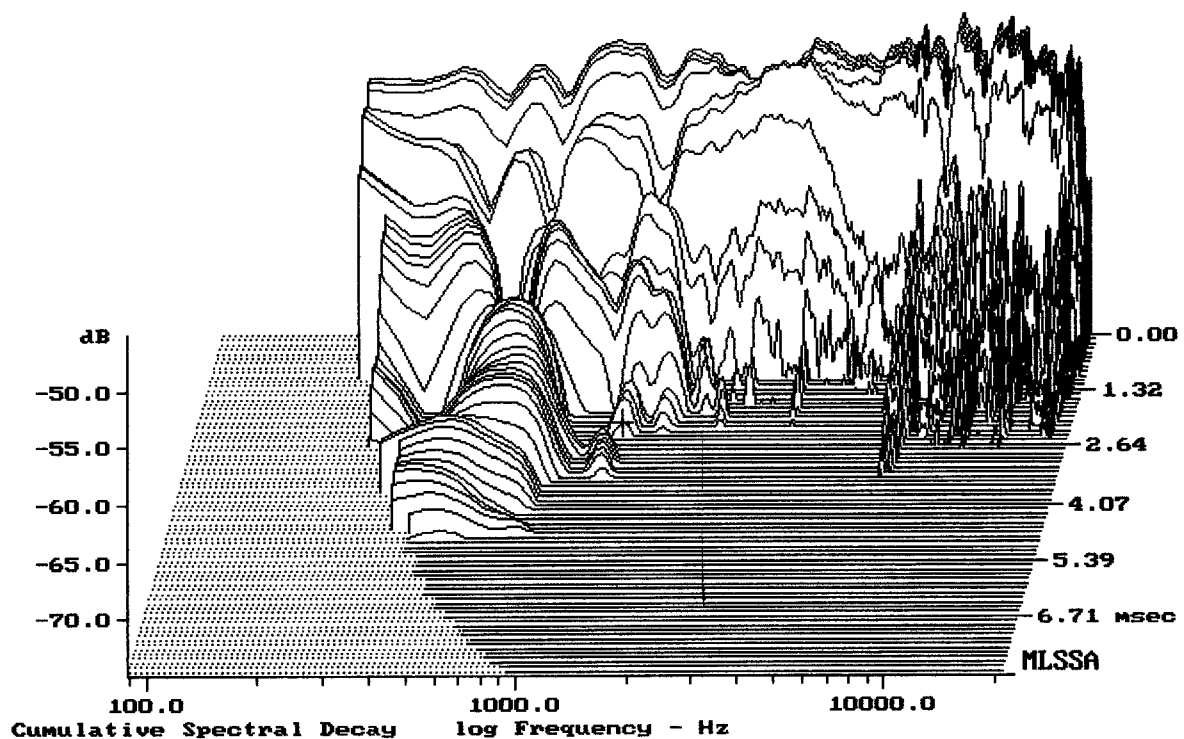

-73.87 dB, 1287 Hz (29), 2.420 msec (23)

Výhybka ze schématu - D220Ti

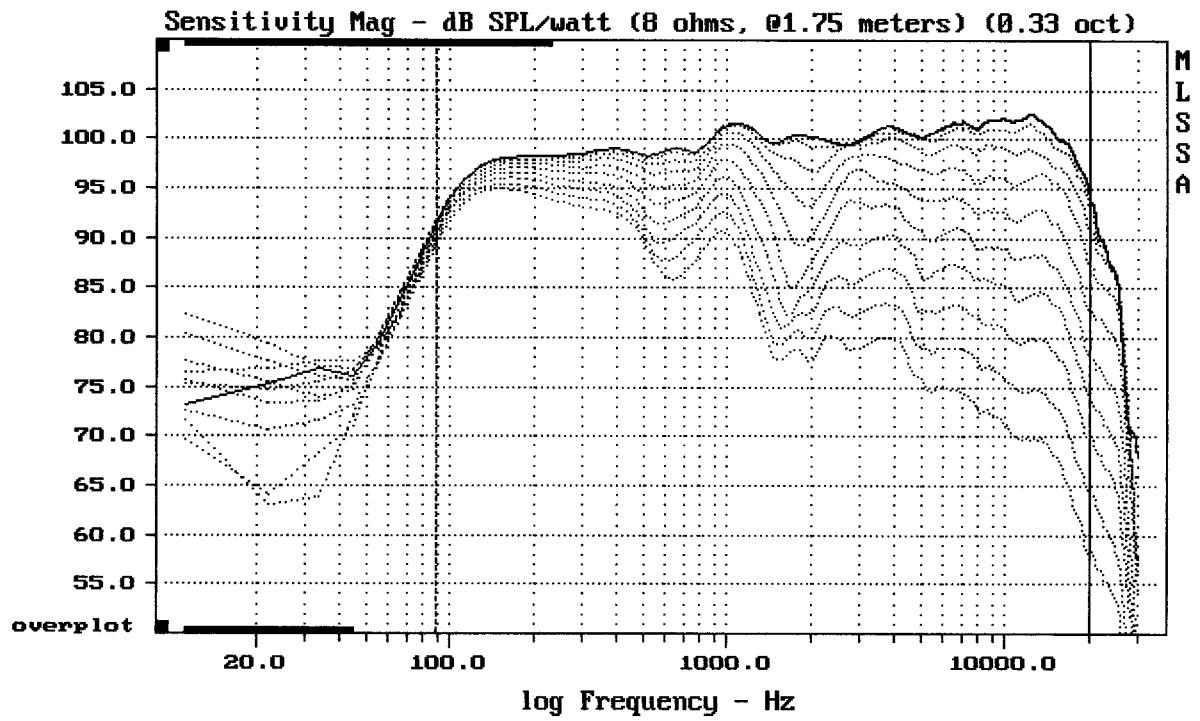

Overlay Compare: dev= +26/-8.8, std= 6.8, avg= -28

DELTA15 + D220TI + HM25-25

MLSSA: Frequency Domain

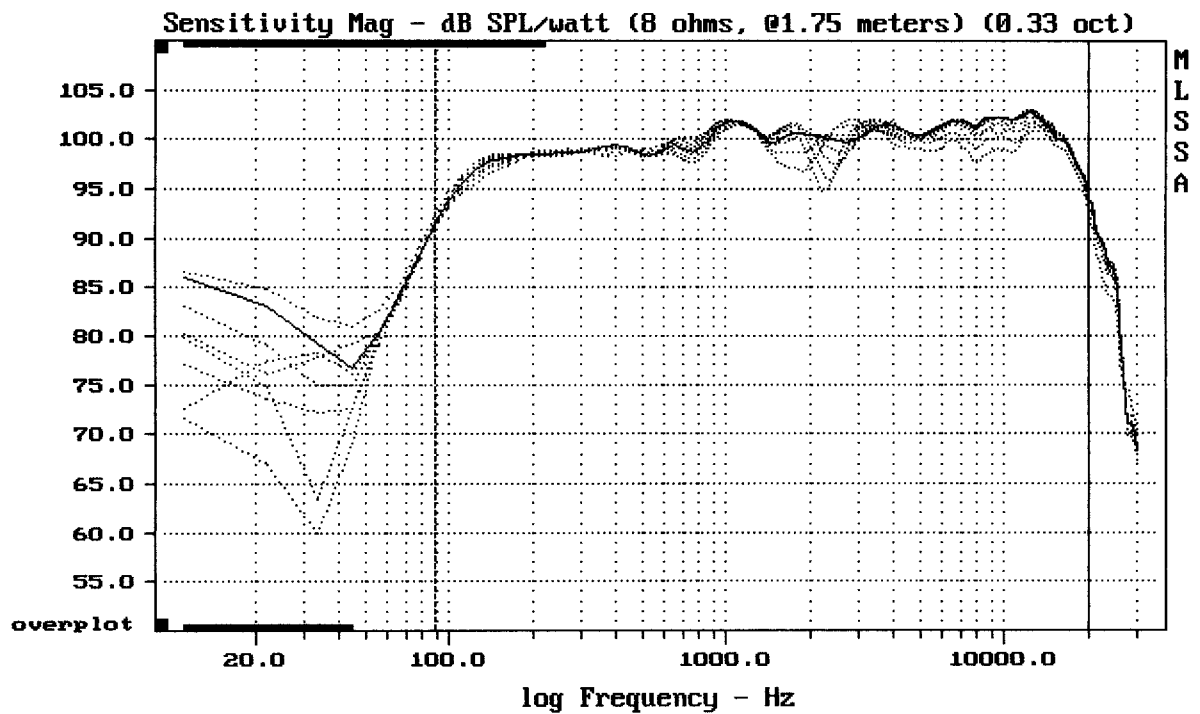

mean: 100.52, rms: 100.68, std: 1.53, max: 102.93, min: 92.26

DELTA15 + D220TI + HM25-25

Výhybka ze schématu - D220Ti

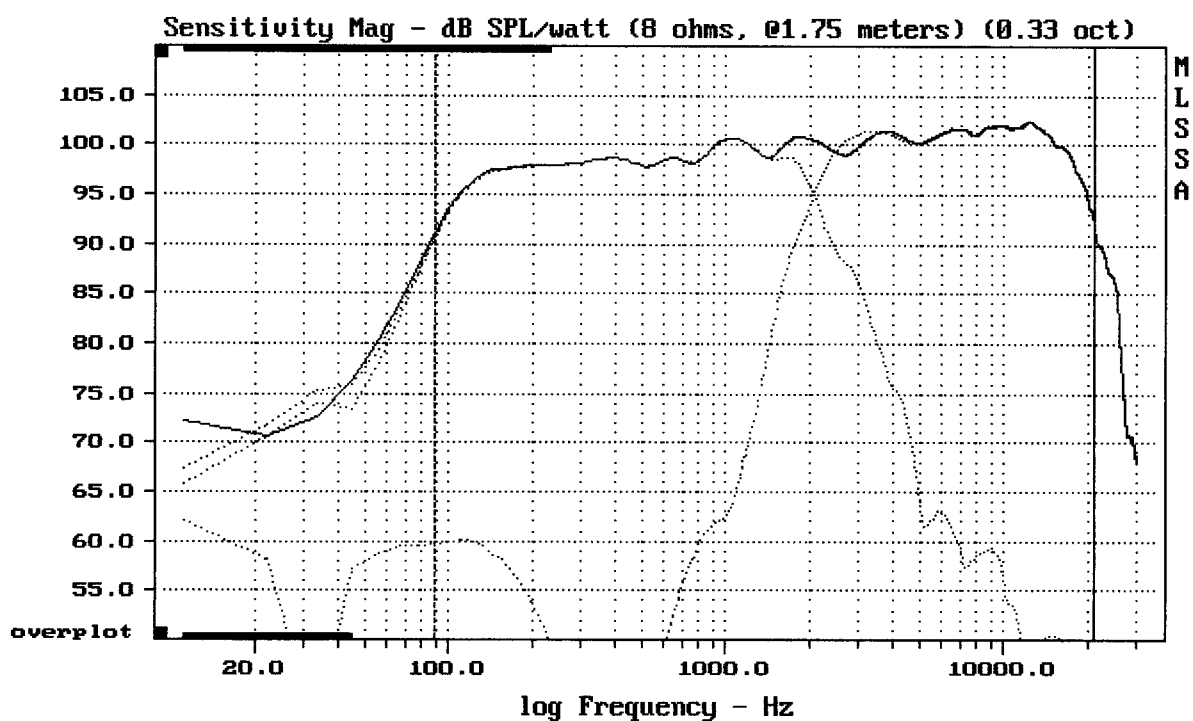

Level (89:21007 Hz) = 99.57 dB SPL/watt (8 ohms, @1.75 meters) (0.33 oct)

DELTA15 + D220TI + HM25-25

MLSSA: Frequency Domain

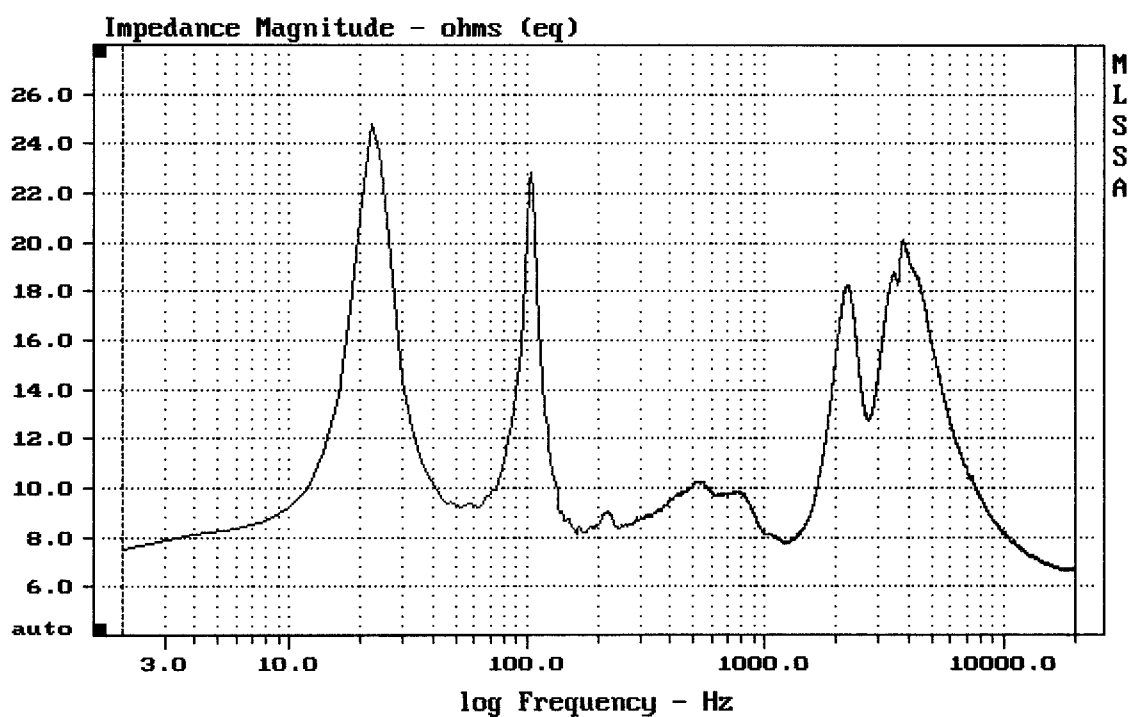

mean: 9.766, rms: 10.47, std: 3.774, max: 24.84, min: 6.626

DELTA15 + D220TI + HM25-25

Výhybka ze schématu - D220Ti
- s odporem 1R