

Sestava B&C Speakers 10PLB76 + DE500 + Megaton A9090m

Osazení:

- B&C Speakers 10PLB76 8/Ohm
<http://eshop.prodance.cz/DetailPage.asp?DPG=82644>
- B&C Speakers DE500 8/Ohm
<http://eshop.prodance.cz/DetailPage.asp?DPG=82312>
- Megaton A9090m
<http://eshop.prodance.cz/DetailPage.asp?DPG=83921>

Schéma výhybky:

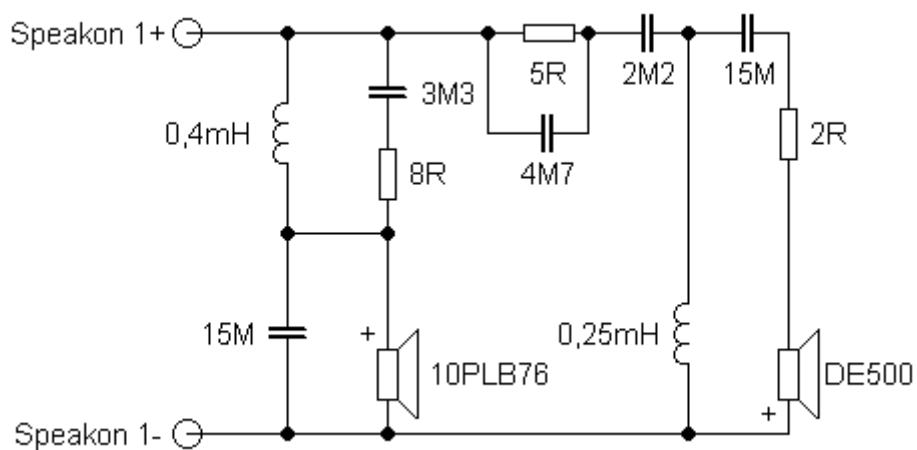

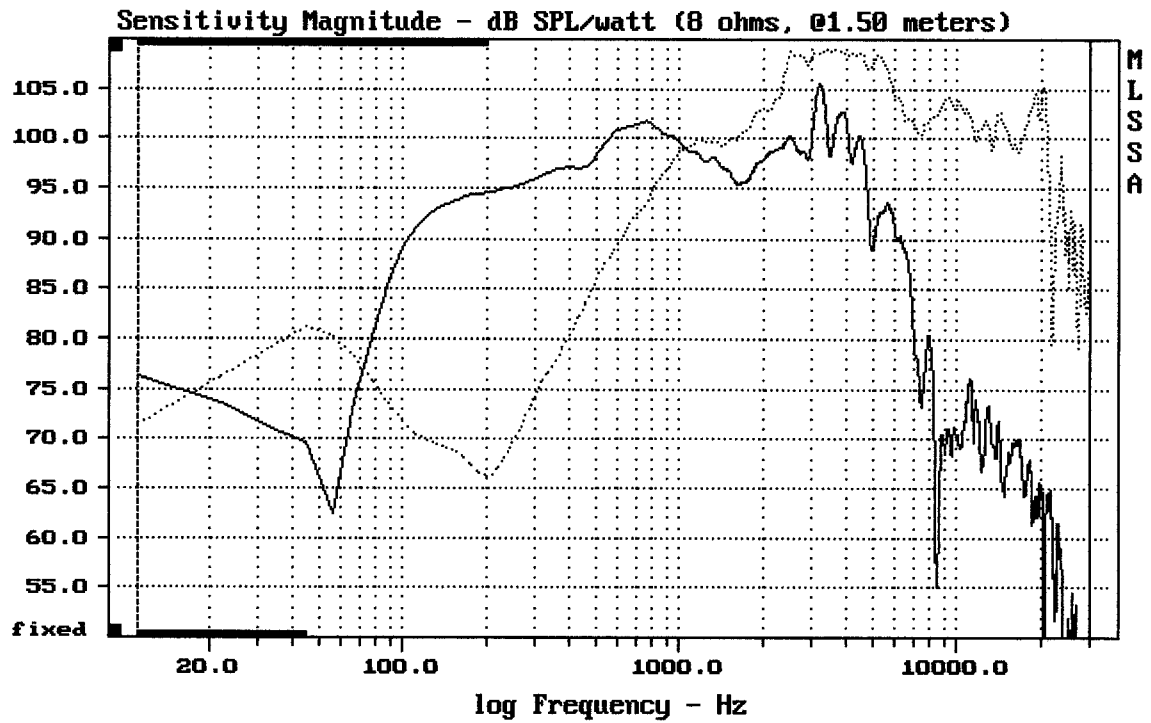

CURSOR: $\Delta y = 24.1191$ $x = 30007.1014$ (2704)

10PLB76 + DE500 + A9090m

MLSSA: Frequency Domain

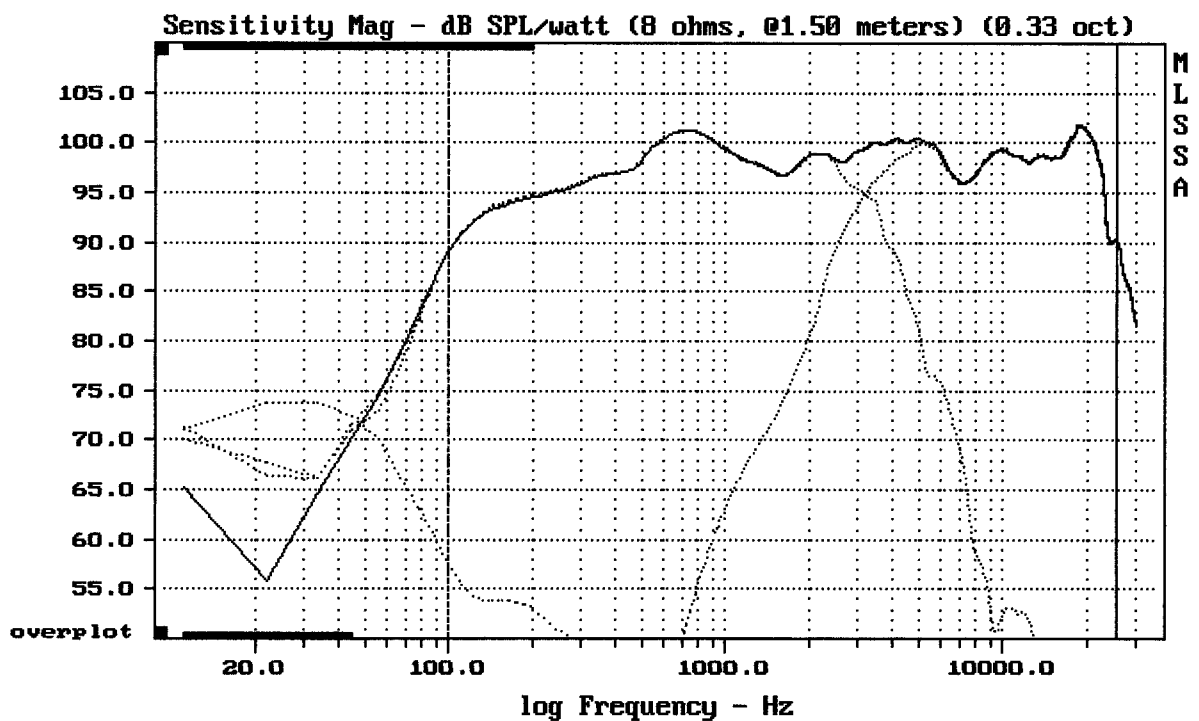

Level (100:255502 Hz) = 98.28 dB SPL/watt (8 ohms, @1.50 meters) (0.33 oct)

10PLB76 + DE500 + A9090m

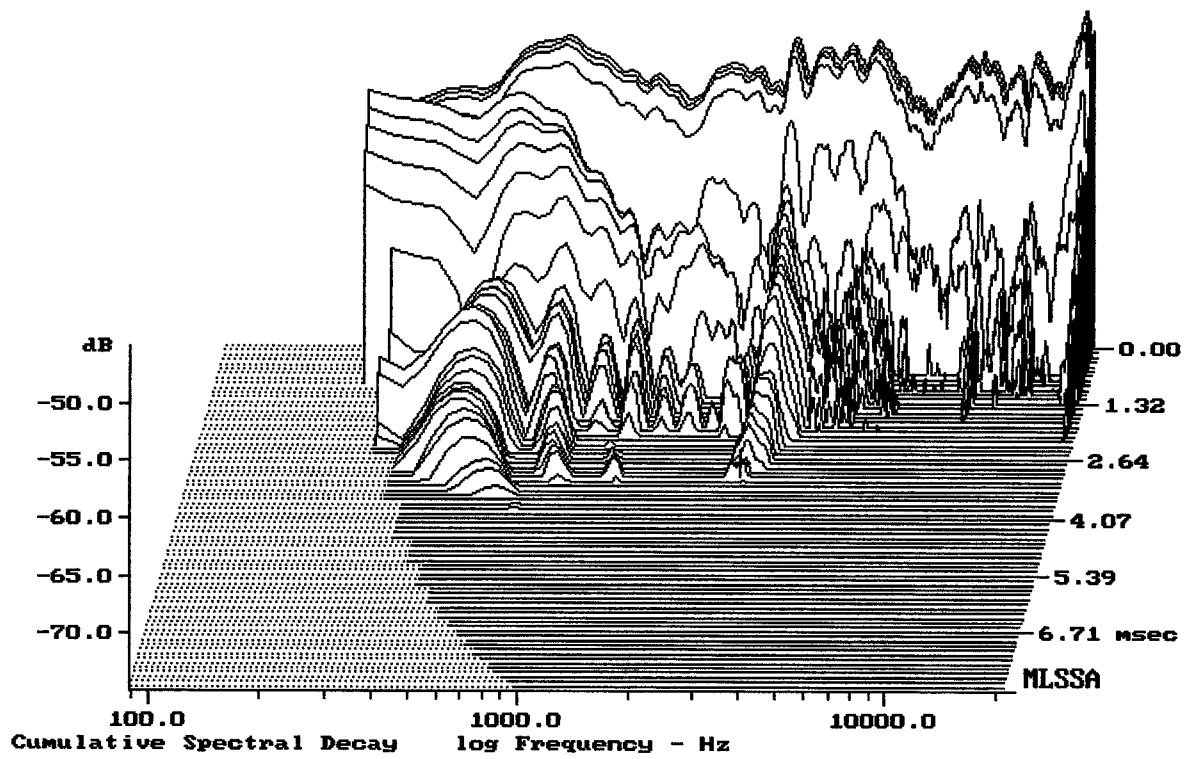

-74.17 dB, 2752 Hz (62), 2.970 msec (28)

DTTO

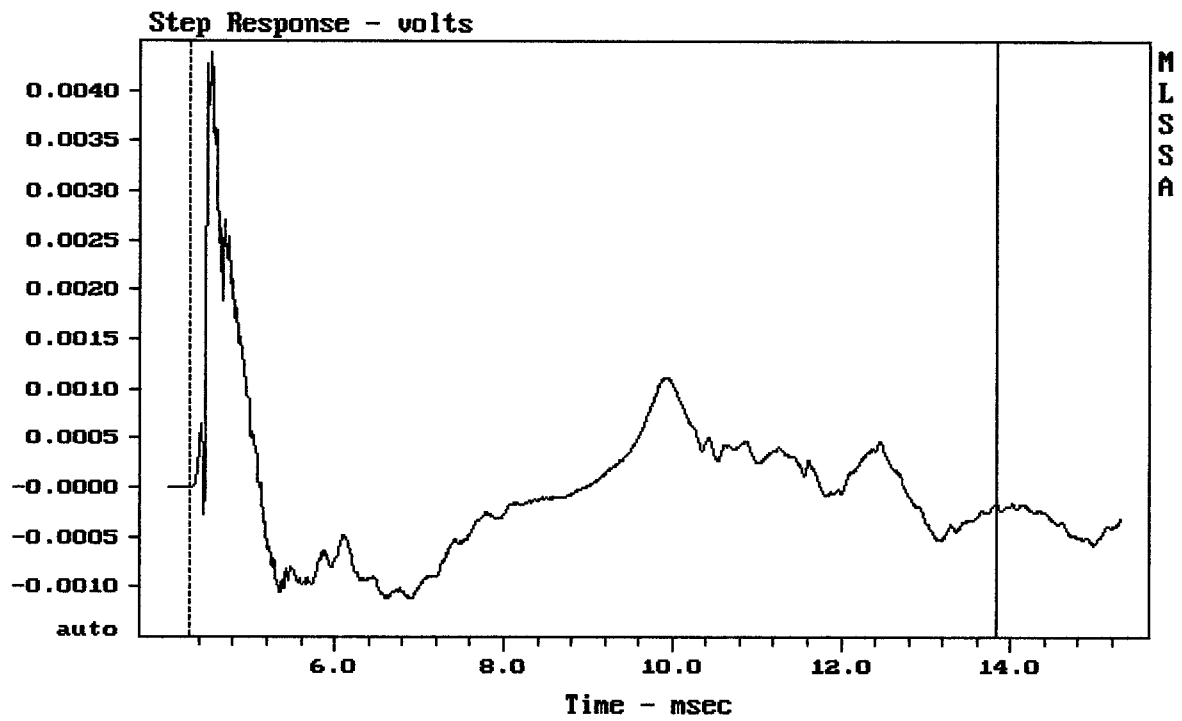

mean: 1.471e-006, rms: 0.000805, std: 0.000805, max: 0.004386, min: -0.001115

10PLB76 + DE500 + A9090m

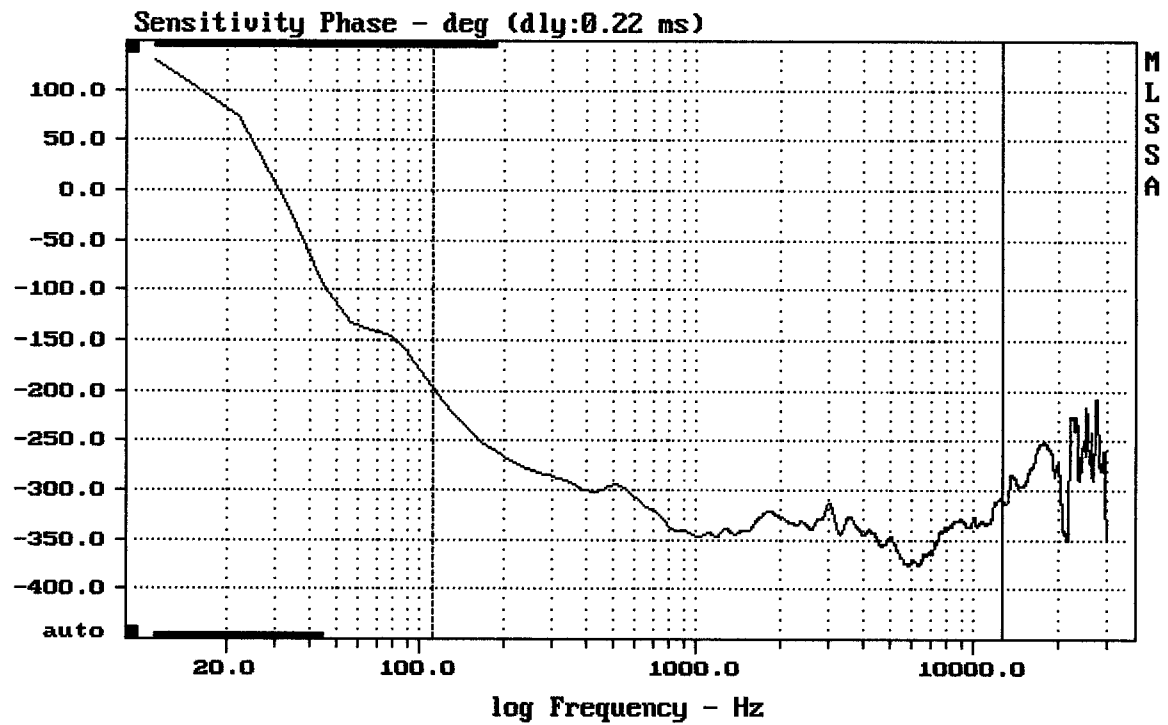

mean: -337.5, rms: 338.1, std: 20.23, max: -196.3, min: -376.8

10PLB76 + DE500 + A9090m

MLSSA: Frequency Domain

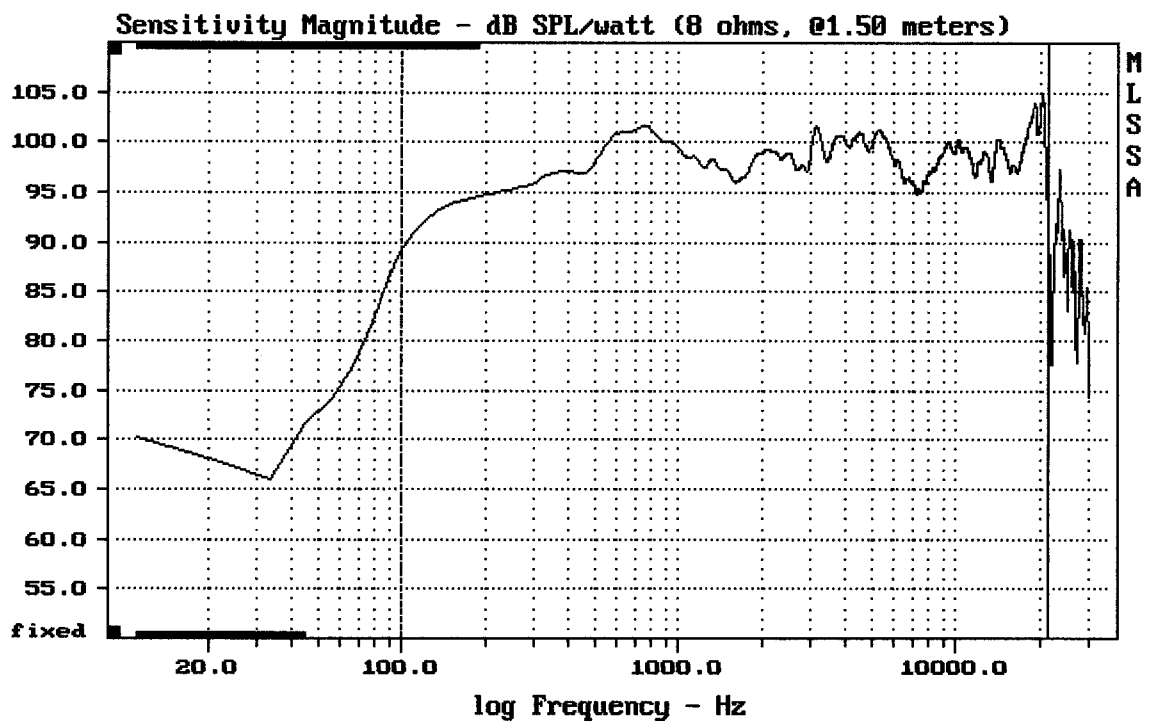

mean: 99.22, rms: 99.50, std: 1.99, max: 104.69, min: 89.27

10PLB76 + DE500 + A9090m

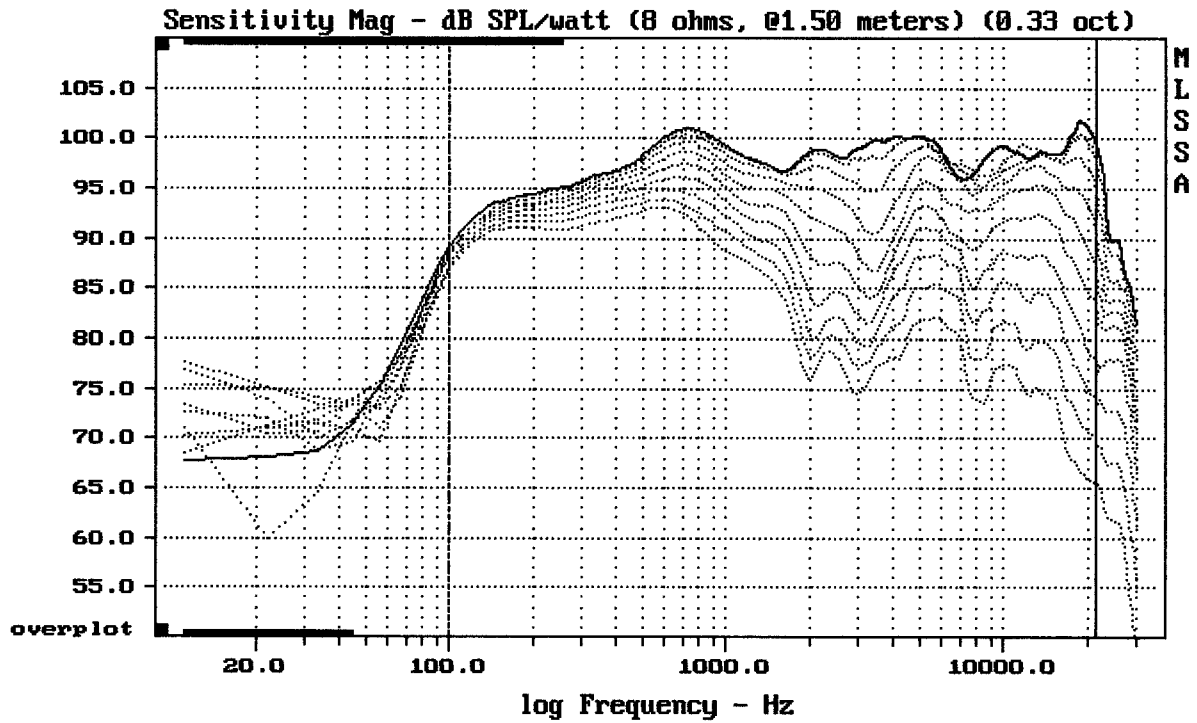

Overlay Compare: dev= +21/-11, std= 7, avg= -24

10PLB76 + DE500 + A9090m

MLSSA: Frequency Domain

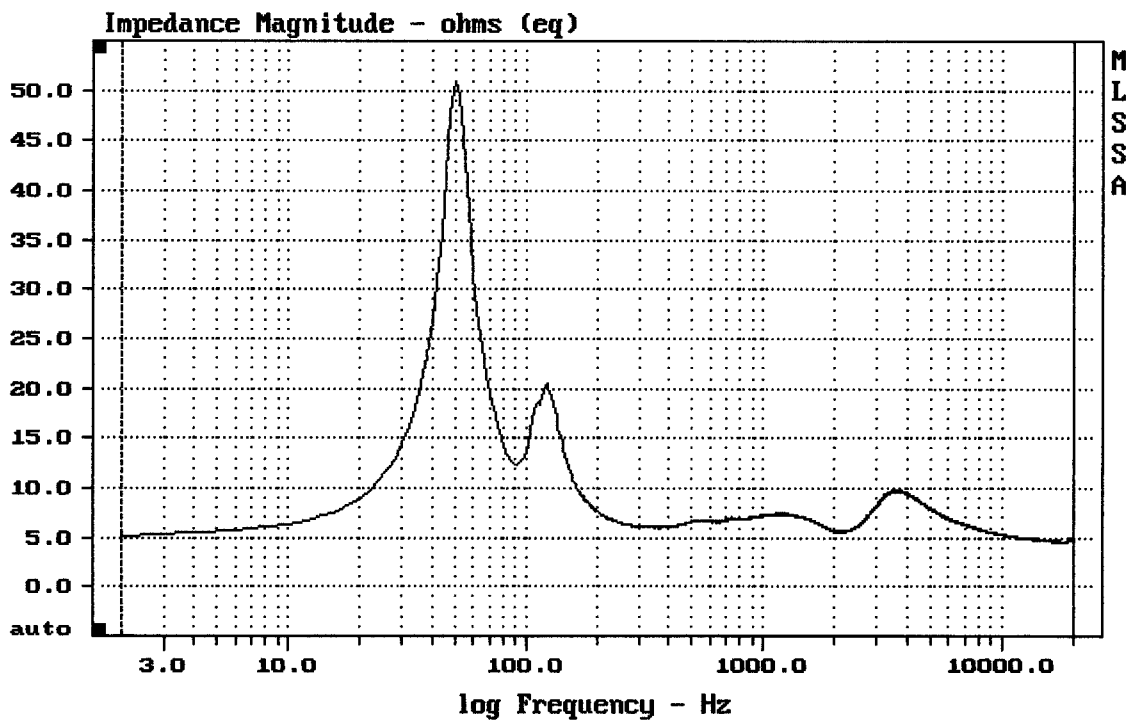

mean: 5.962, rms: 6.285, std: 1.988, max: 50.87, min: 4.564

10PLB76 + DE500 + A9090m