

Sestava B&C Speakers 15PLB76 + DE250/16 + Megaton A9090

Osazení:

- B&C Speakers 15PLB76 8/Ohm
<http://eshop.prodance.cz/DetailPage.asp?DPG=82890>
- B&C Speakers DE250/16 16/Ohm
<http://eshop.prodance.cz/DetailPage.asp?DPG=82305>
- Megaton A9090
<http://eshop.prodance.cz/DetailPage.asp?DPG=83920>

Schéma výhybky:

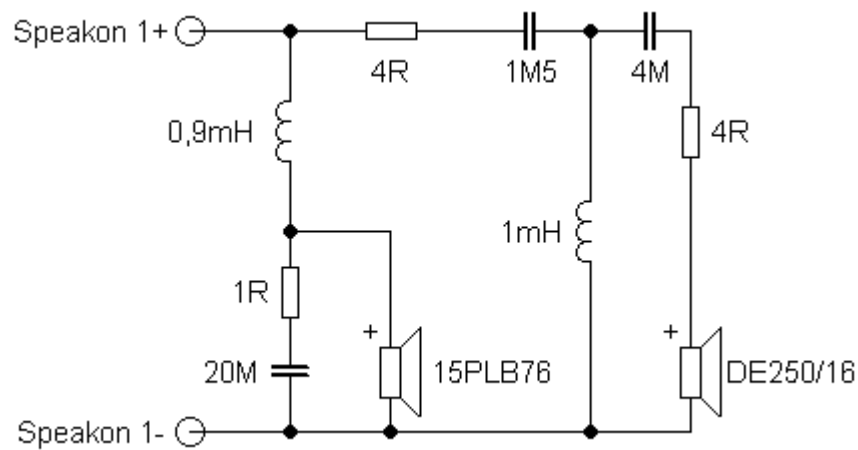

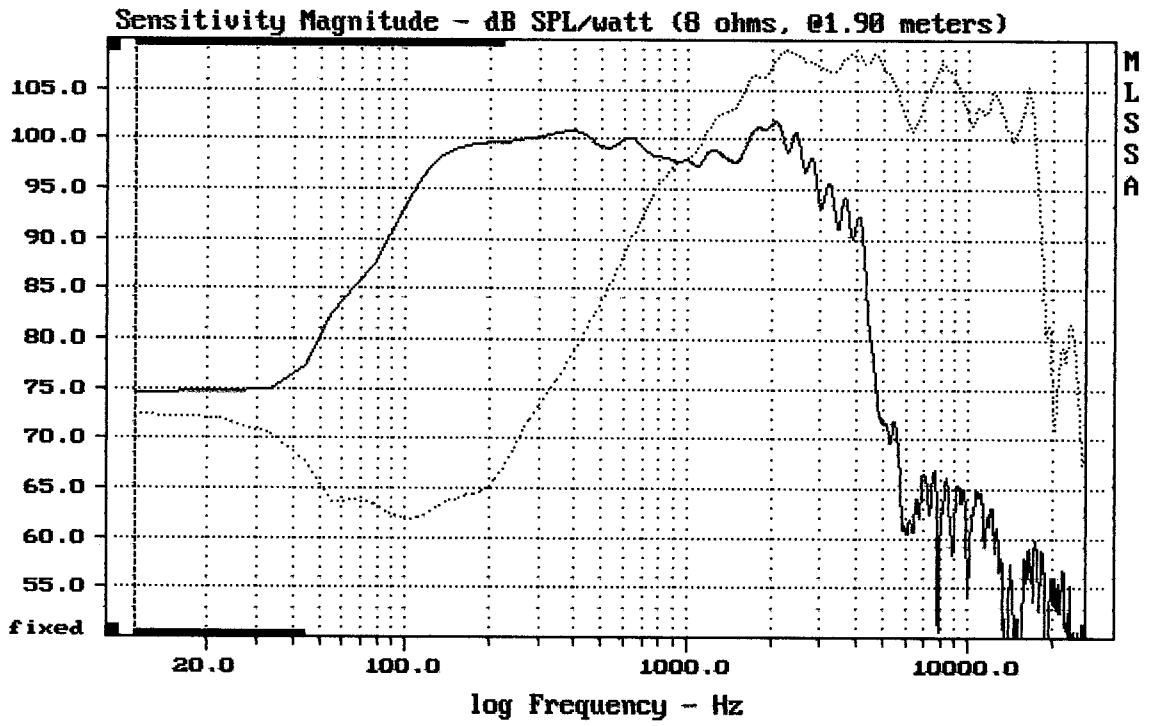

CURSOR: $\Delta y = 15.7228$ $x = 26045.3650$ (2347)

15PLB76 + DE250/16 + A9090

MLSSA: Frequency Domain

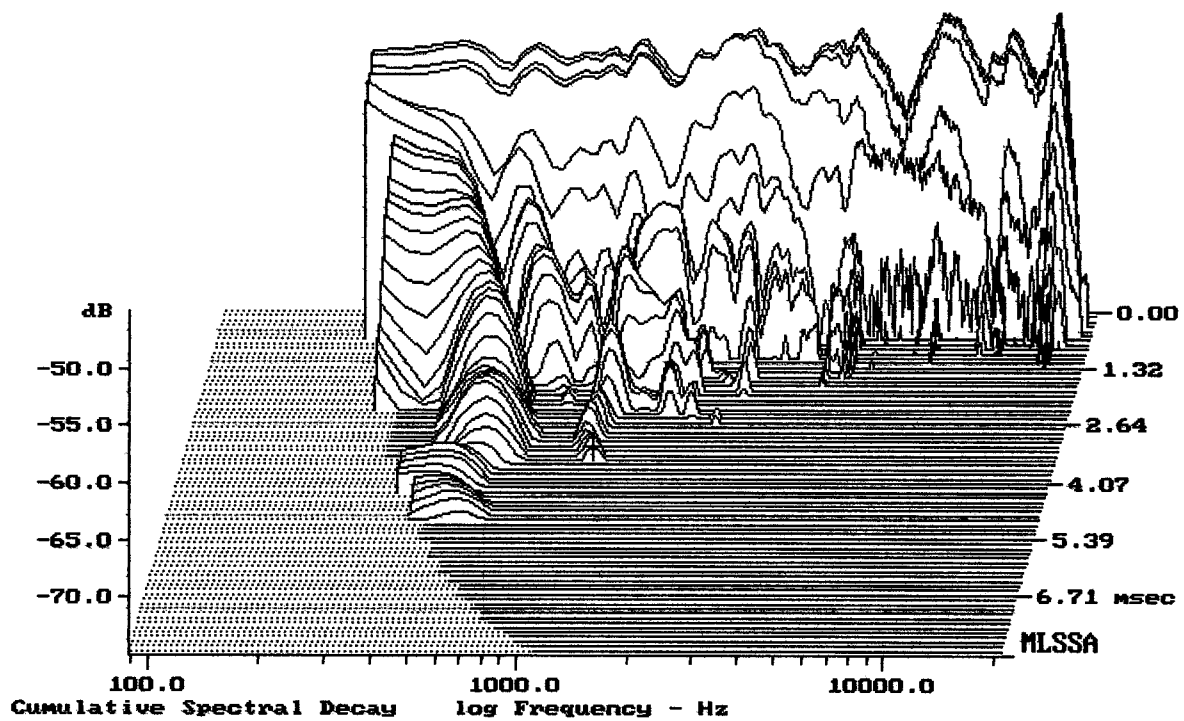

-73.77 dB, 1154 Hz (26), 3.520 msec (33)

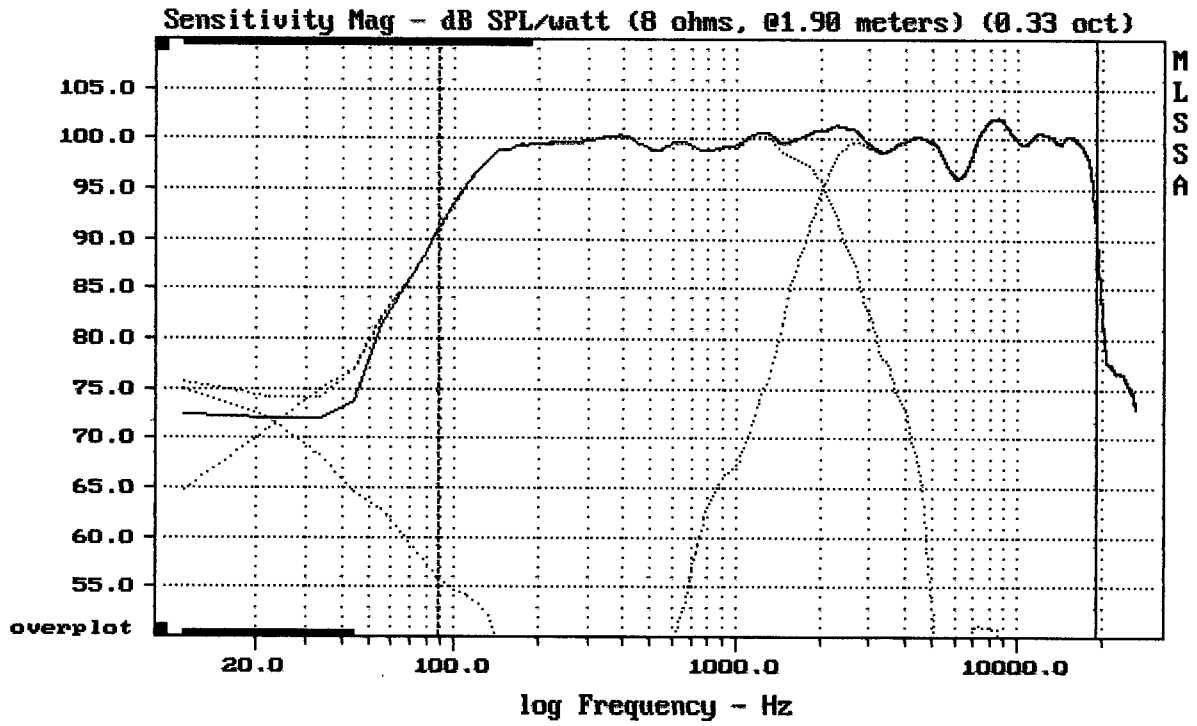

Level (89:18999 Hz) = 99.53 dB SPL/watt (8 ohms, 01.90 meters) (0.33 oct)

15PLB76 + DE250/16 + A9090

MLSSA: Frequency Domain

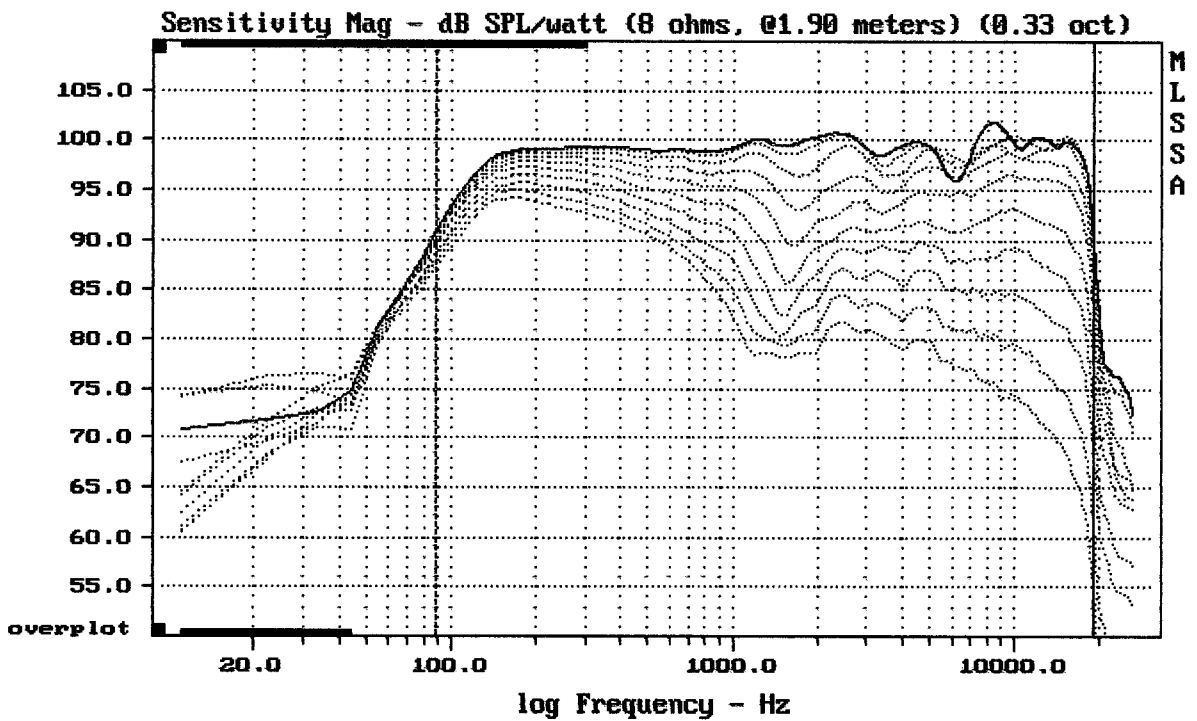

Overlay Compare: dev= +22/-10, std= 6.5, avg= -25

15PLB76 + DE250/16 + A9090

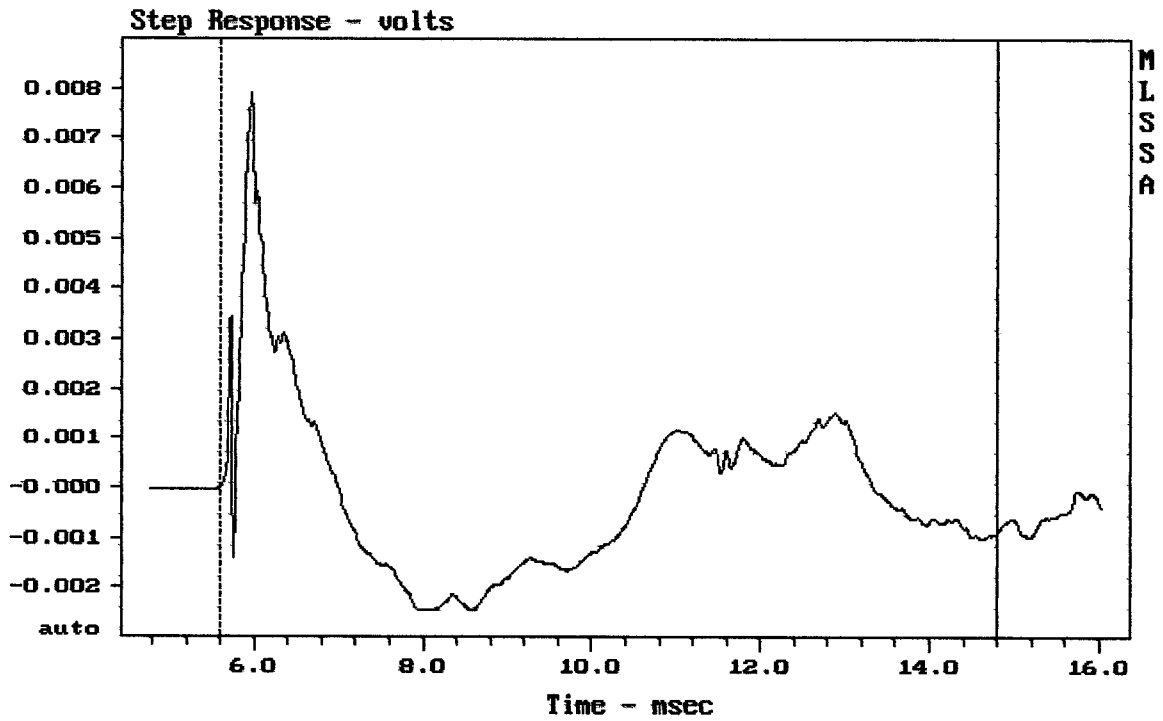

mean: -0.000111, rms: 0.001738, std: 0.001735, max: 0.007898, min: -0.002467

15PLB76 + DE250/16 + A9090

MLSSA: Time Domain

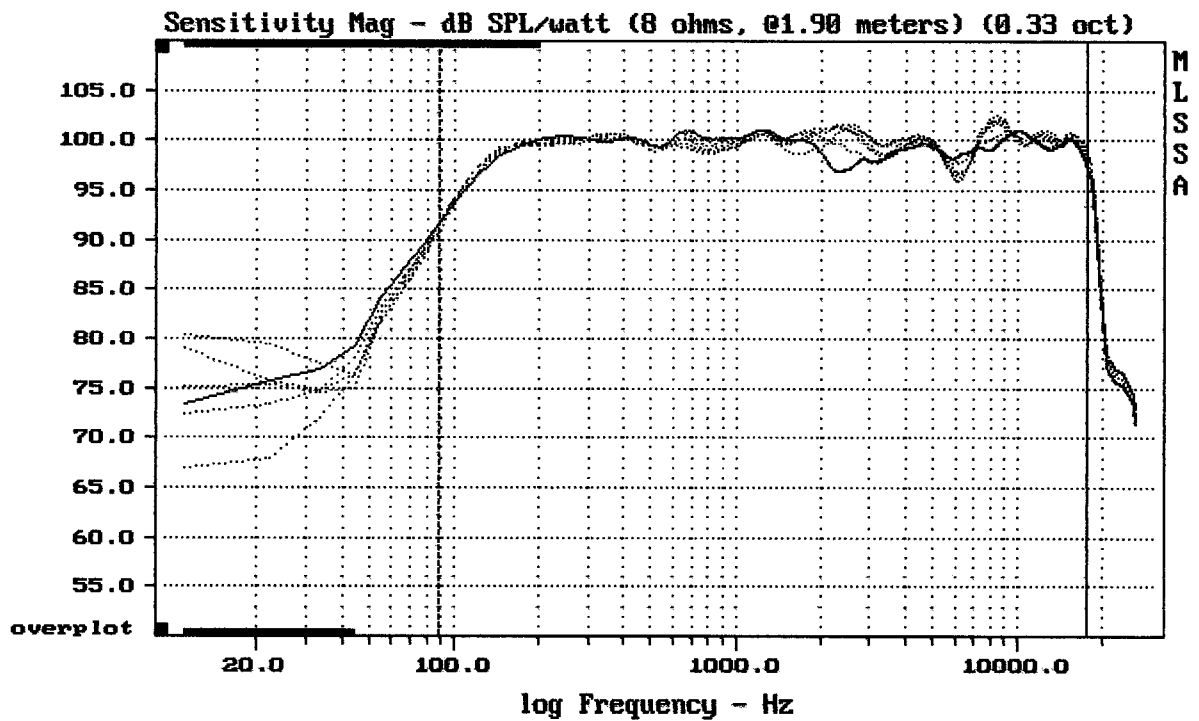

mean: 100.14, rms: 100.21, std: 1.00, max: 102.18, min: 91.54

15PLB76 + DE250/16 + A9090

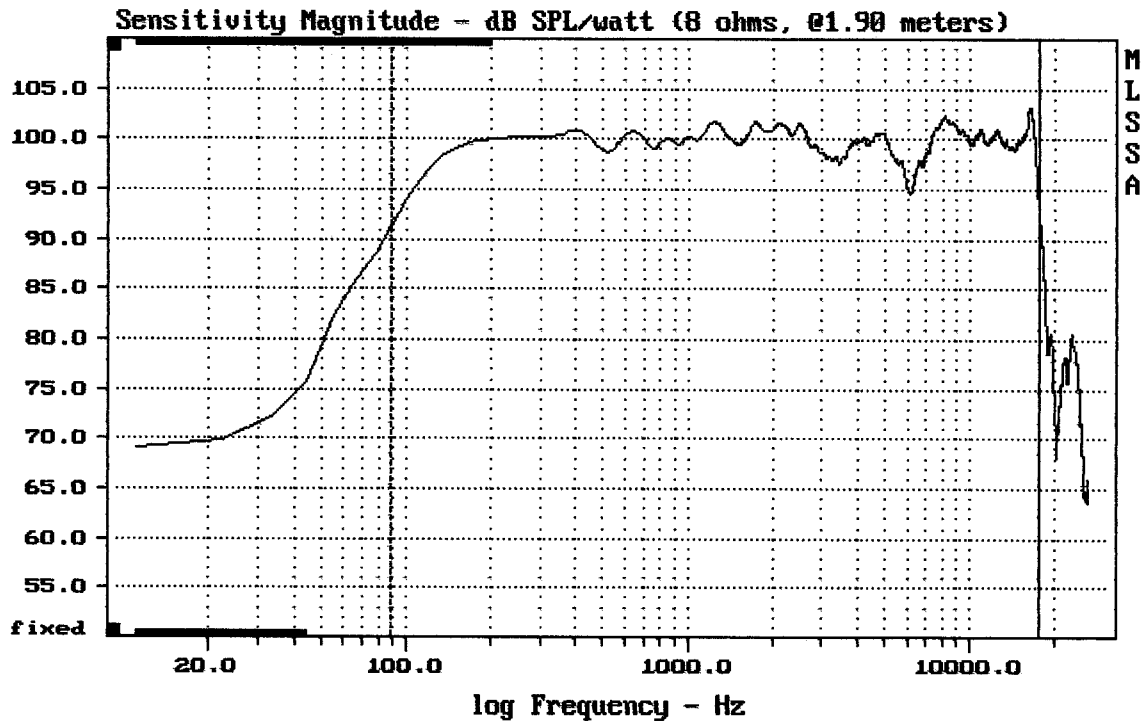

mean: 100.00, rms: 100.13, std: 1.36, max: 103.15, min: 91.33

15PLB76 + DE250/16 + A9090

MLSSA: Frequency Domain

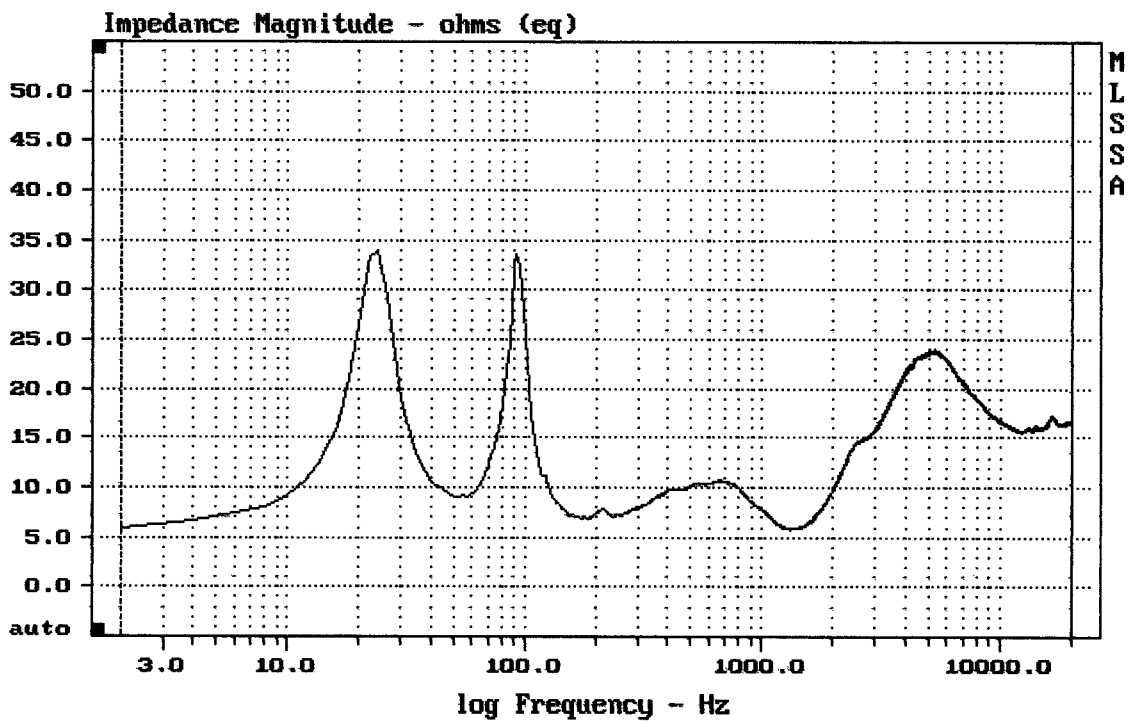

mean: 16.74, rms: 17.18, std: 3.853, max: 34, min: 5.796

15PLB76 + DE250/16 + A9090