

## Sestava B&C Speakers 15NDL76 + DE250 + Megaton A1160

### Osazení:

- B&C Speakers 15NDL76 8/Ohm  
<http://eshop.prodance.cz/DetailPage.asp?DPG=82860>
- B&C Speakers DE250 8/Ohm  
<http://eshop.prodance.cz/DetailPage.asp?DPG=82306>
- Megaton A1160  
<http://eshop.prodance.cz/DetailPage.asp?DPG=83839>

### Schéma výhybky:

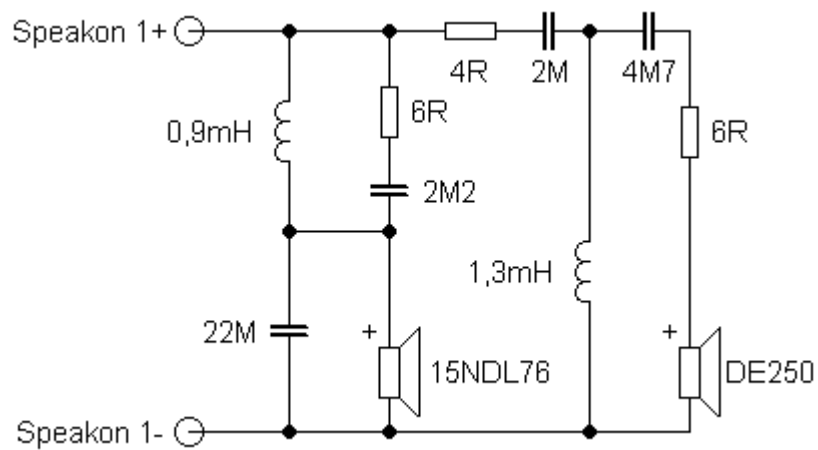

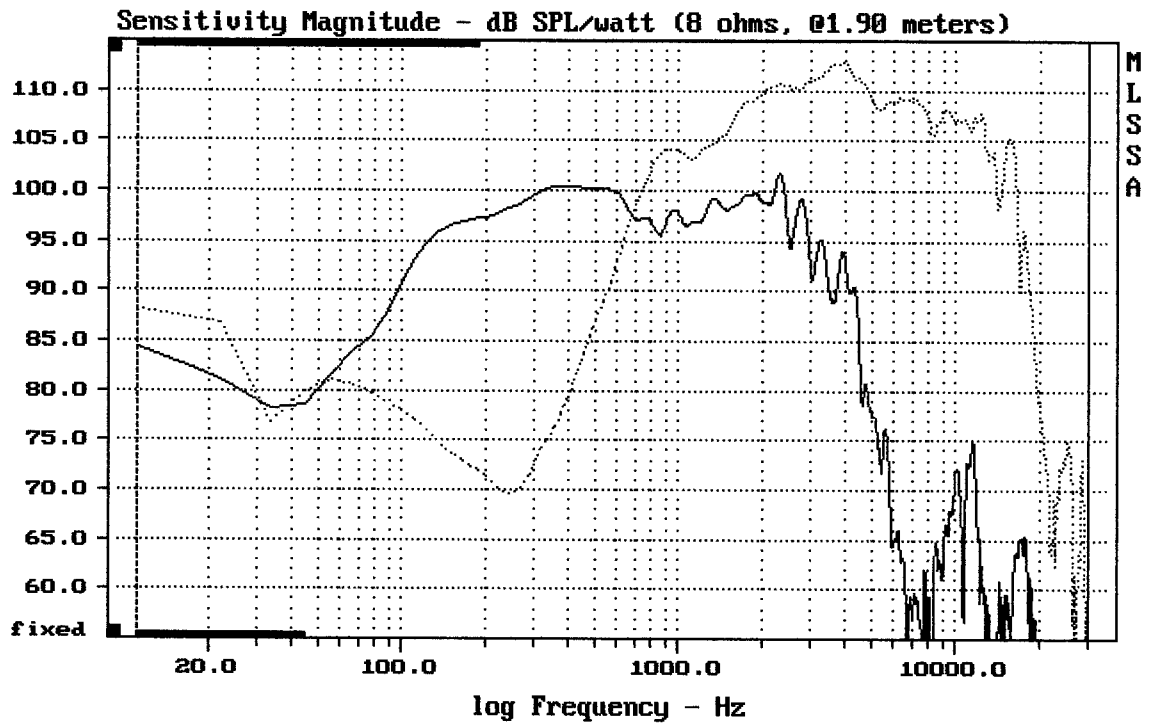

CURSOR:  $\Delta y = 8.16744$   $x = 30007.1014$  (2704)

15NDL76 + DE250 + A1160

MLSSA: Frequency Domain

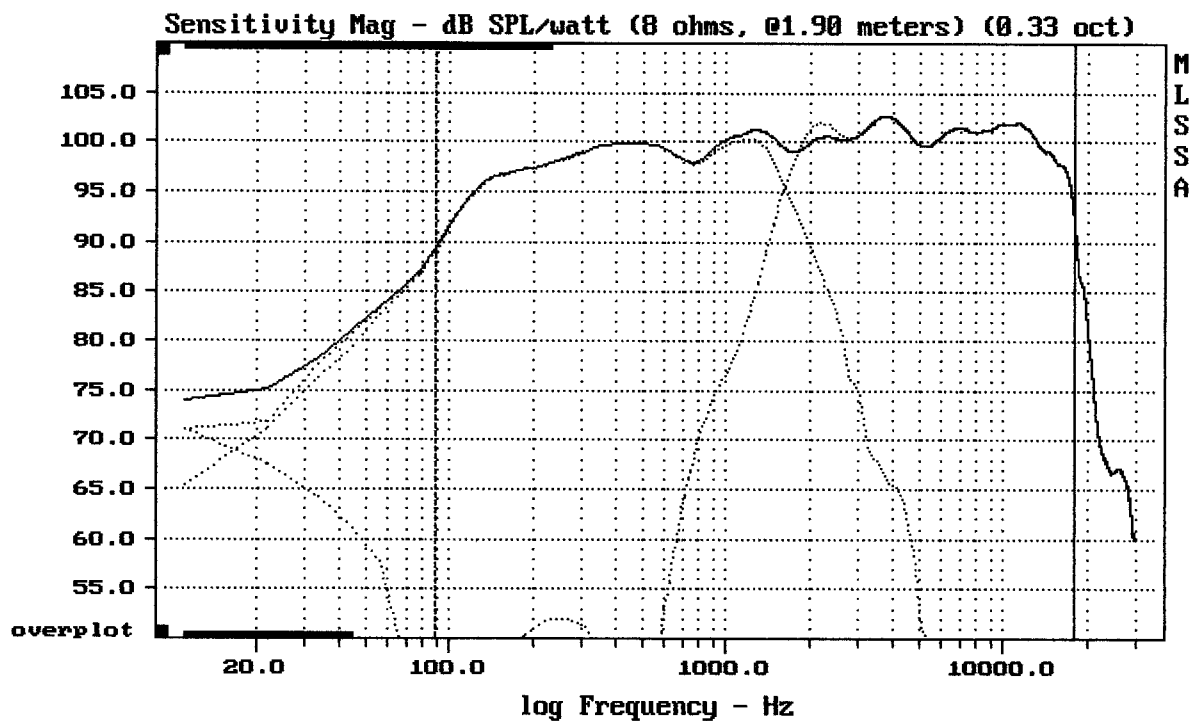

Level (89:10000 Hz) = 99.66 dB SPL/watt (8 ohms, @1.90 meters) (0.33 oct)

15NDL76 + DE250 + A1160

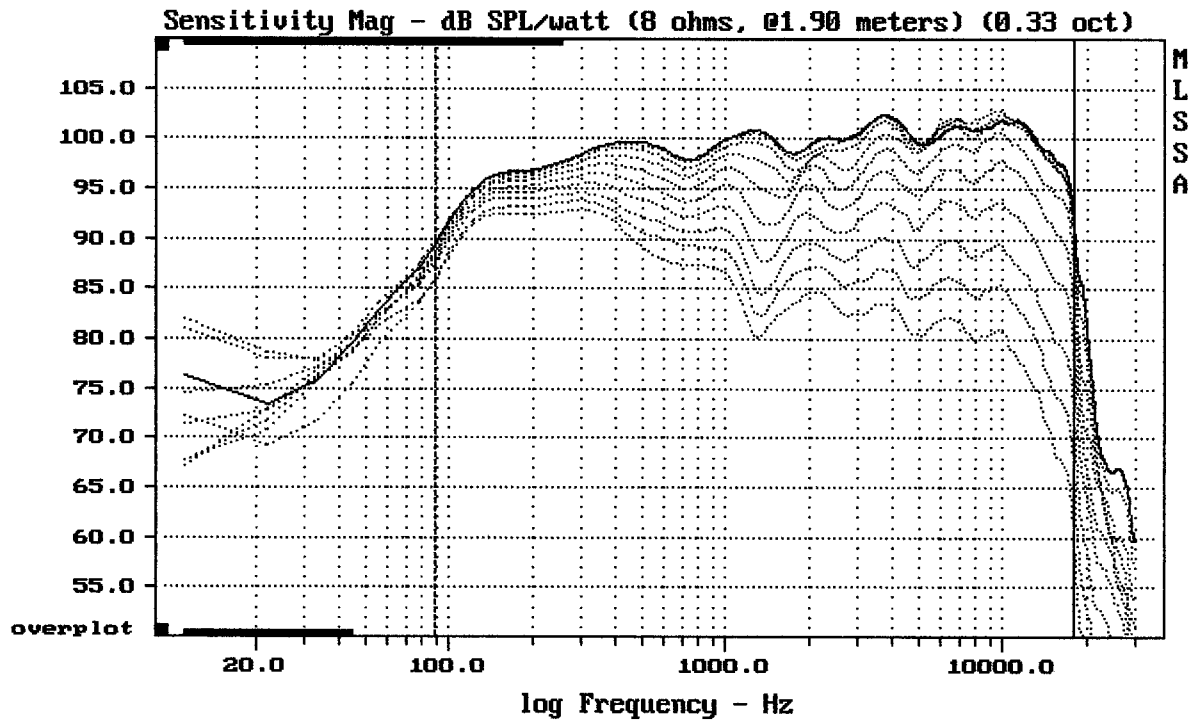

Overlay Compare: dev= +18/-9.5, std= 5.3, avg= -22

15NDL76 + DE250 + A1160

MLSSA: Frequency Domain

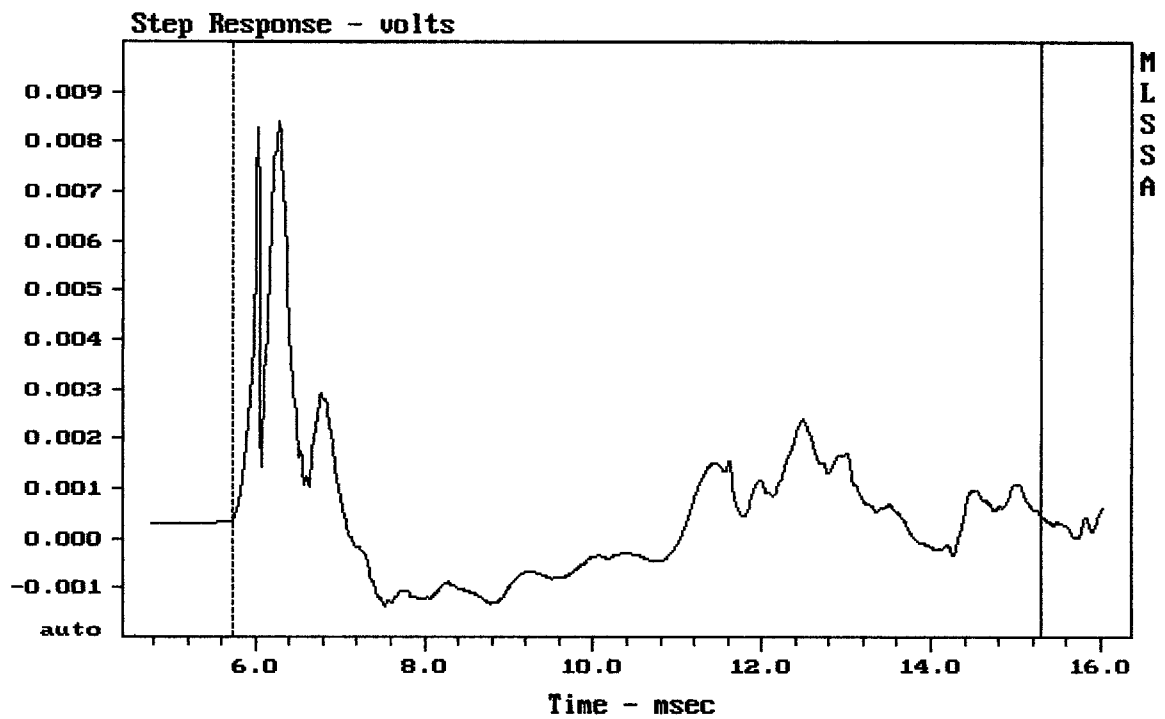

mean: 0.0005033, rms: 0.001688, std: 0.001612, max: 0.008413, min: -0.001358

15NDL76 + DE250 + A1160

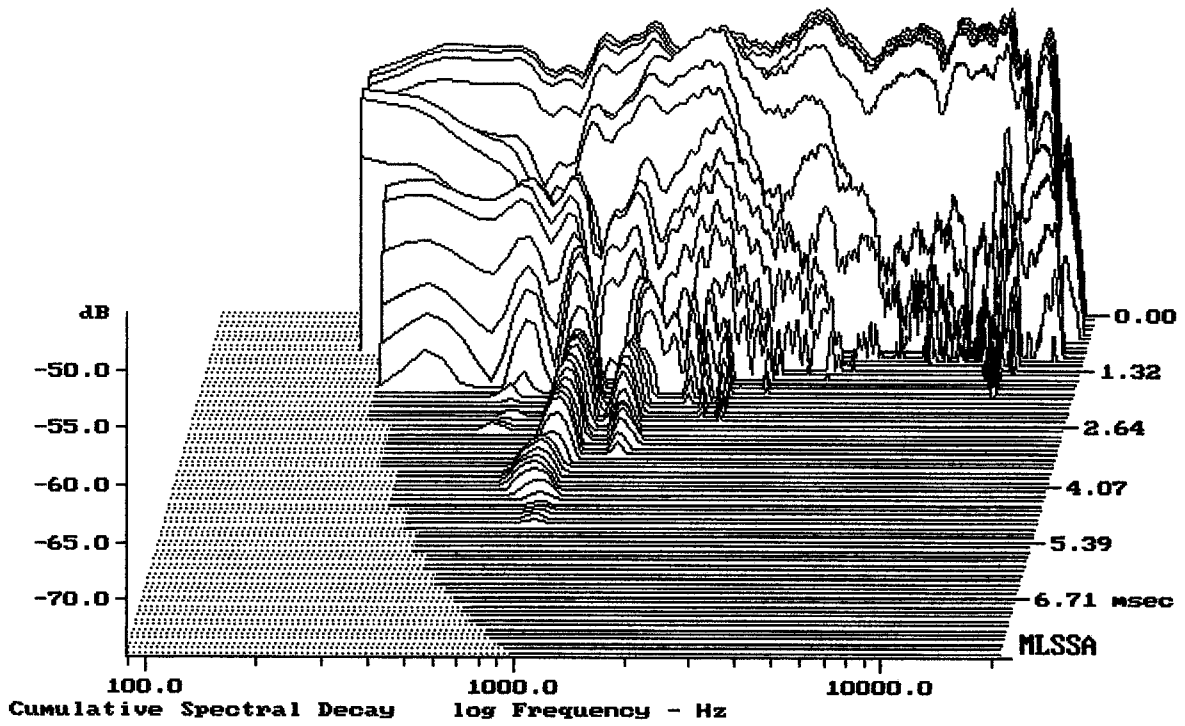

-74.17 dB, 2131 Hz (48), 2.310 msec (22)

DTTO

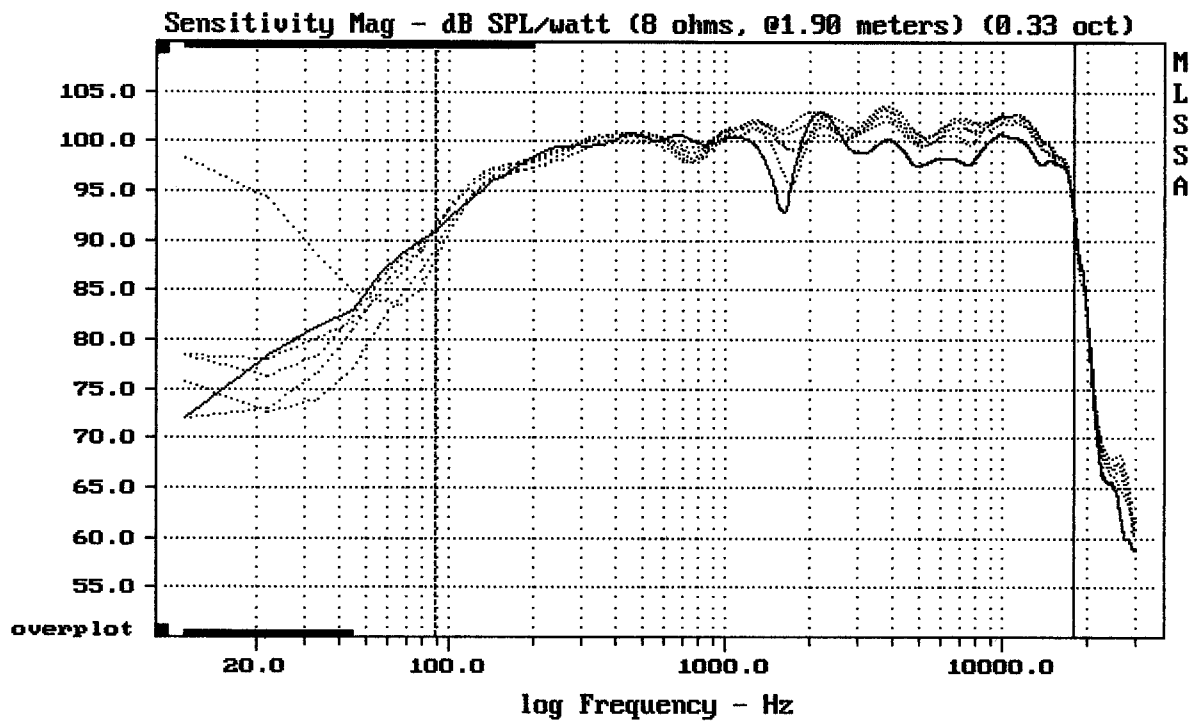

mean: 101.05, rms: 101.23, std: 1.59, max: 103.47, min: 88.08

15NDL76 + DE250 + A1160

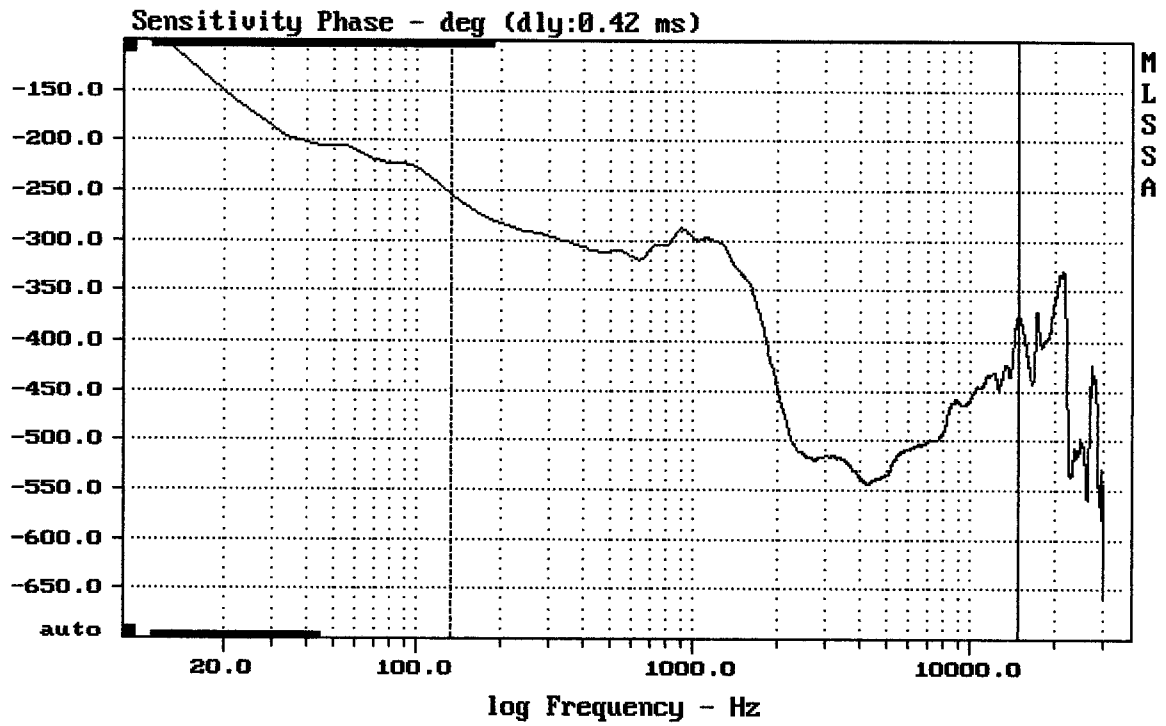



---

mean: -455.9, rms: 460.6, std: 65.3, max: -254.6, min: -544.1

---

15NDL76 + DE250 + A1160

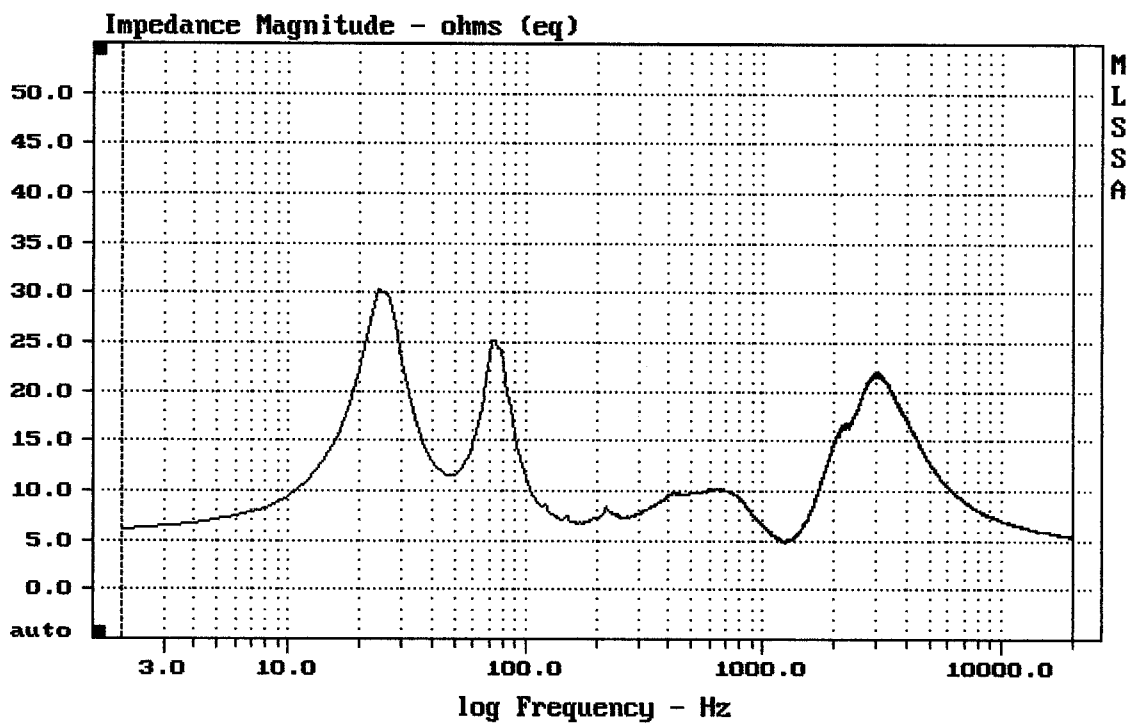
MLSSA: Frequency Domain



---

mean: 8.767, rms: 9.775, std: 4.324, max: 30.31, min: 4.835

---

15NDL76 + DE250 + A1160