

Sestava B&C Speakers 15HPL76 + DE250 + Megaton A7570

Osazení:

- B&C Speakers 15HPL76 8/Ohm
<http://eshop.prodance.cz/DetailPage.asp?DPG=82844>
- B&C Speakers DE250 8/Ohm
<http://eshop.prodance.cz/DetailPage.asp?DPG=82306>
- Megaton A7570
<http://eshop.prodance.cz/DetailPage.asp?DPG=83912>

Schéma výhybky:

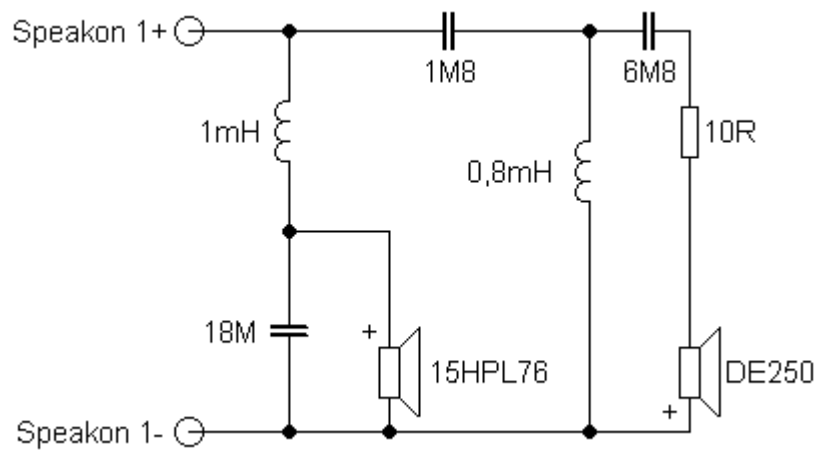

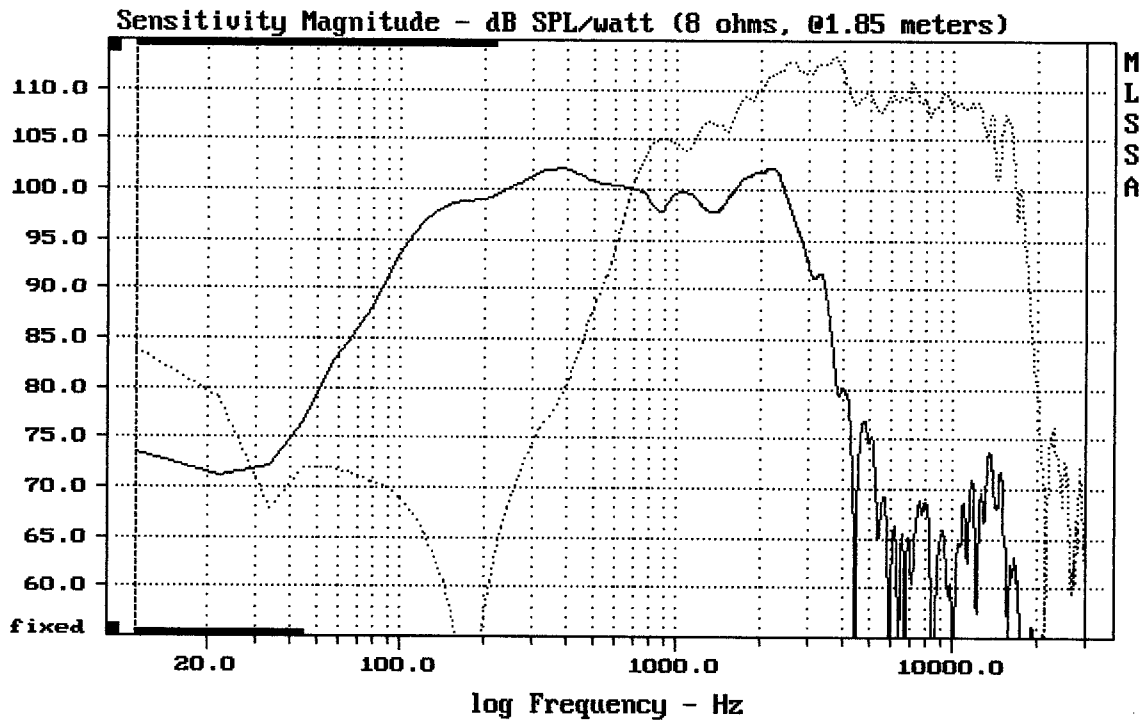

CURSOR: dy = 25.9932 x = 30007.1014 (2704)

15HPL76 + DE250 + A7570

MLSSA: Frequency Domain

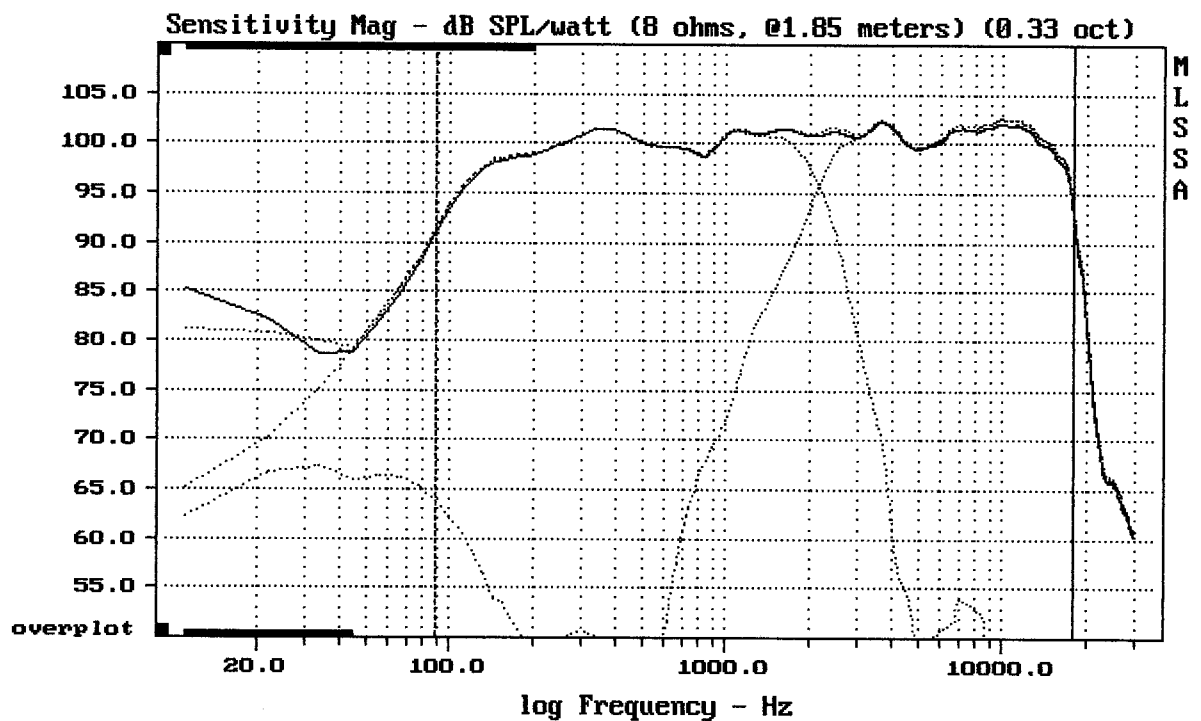

Level (89:18011 Hz) = 100.40 dB SPL/watt (8 ohms, @1.85 meters) (0.33 oct)

15HPL76 + DE250 + A7570

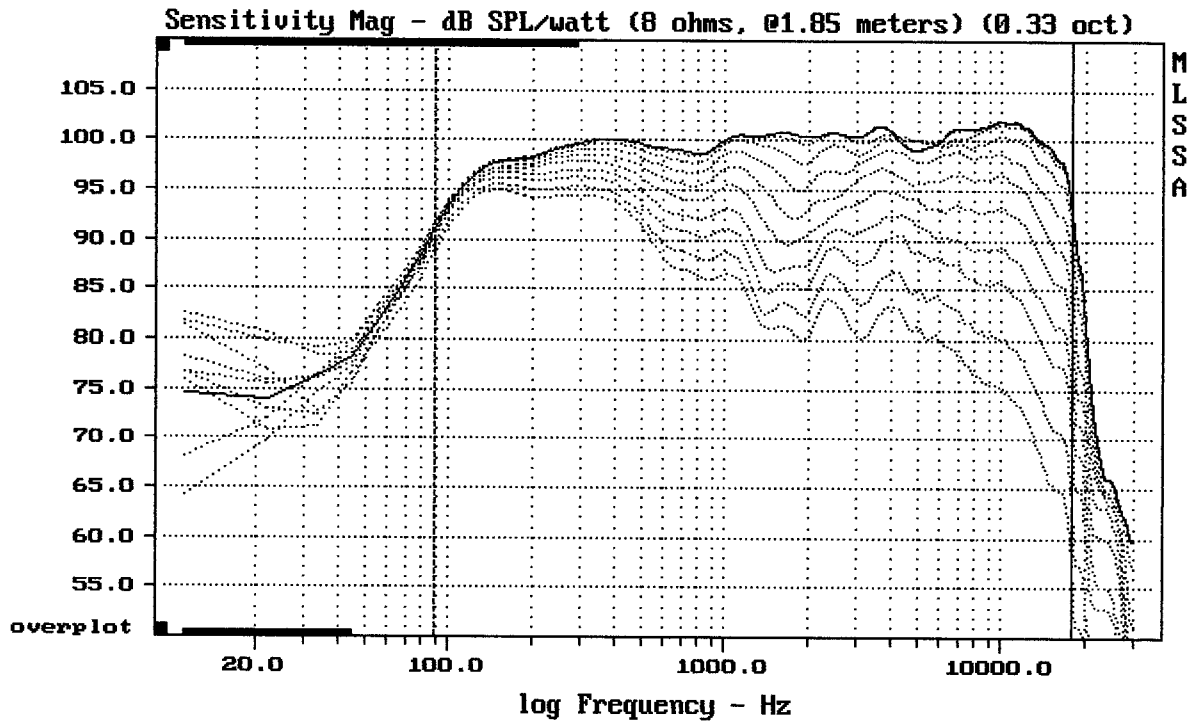

Overlay Compare: dev= +23/-10, std= 6.9, avg= -25

15HPL76 + DE250 + A7570

MLSSA: Frequency Domain

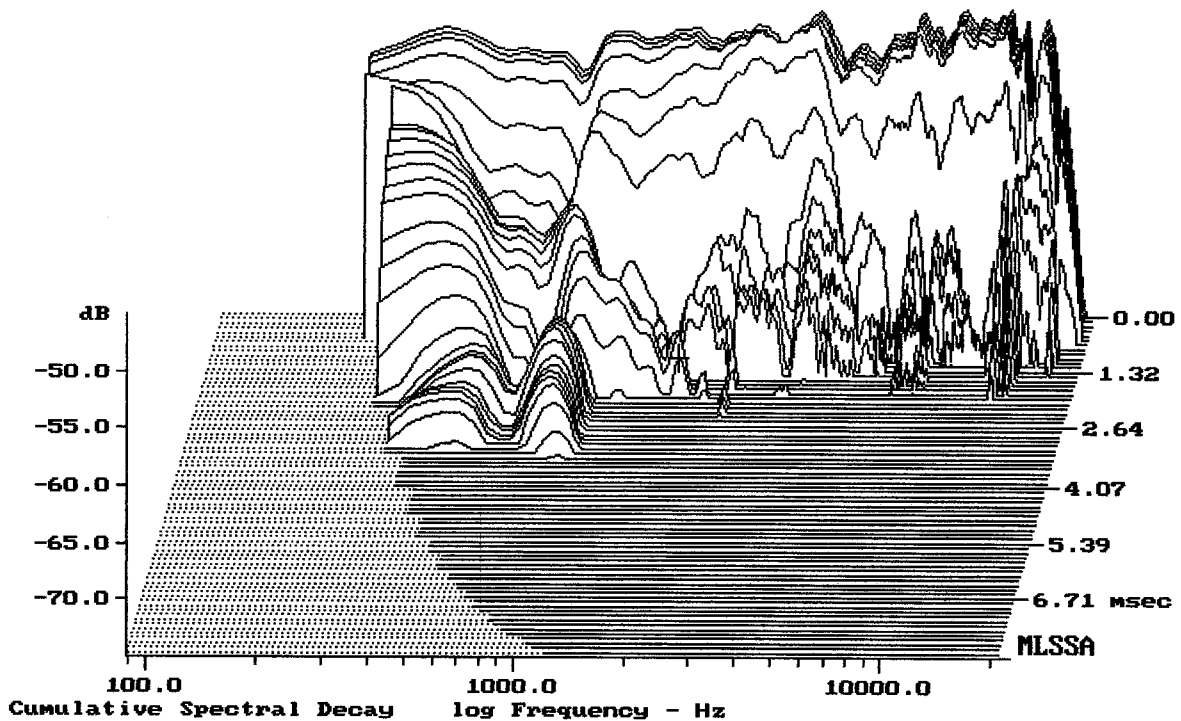

-71.76 dB, 1776 Hz (40), 1.870 msec (18)

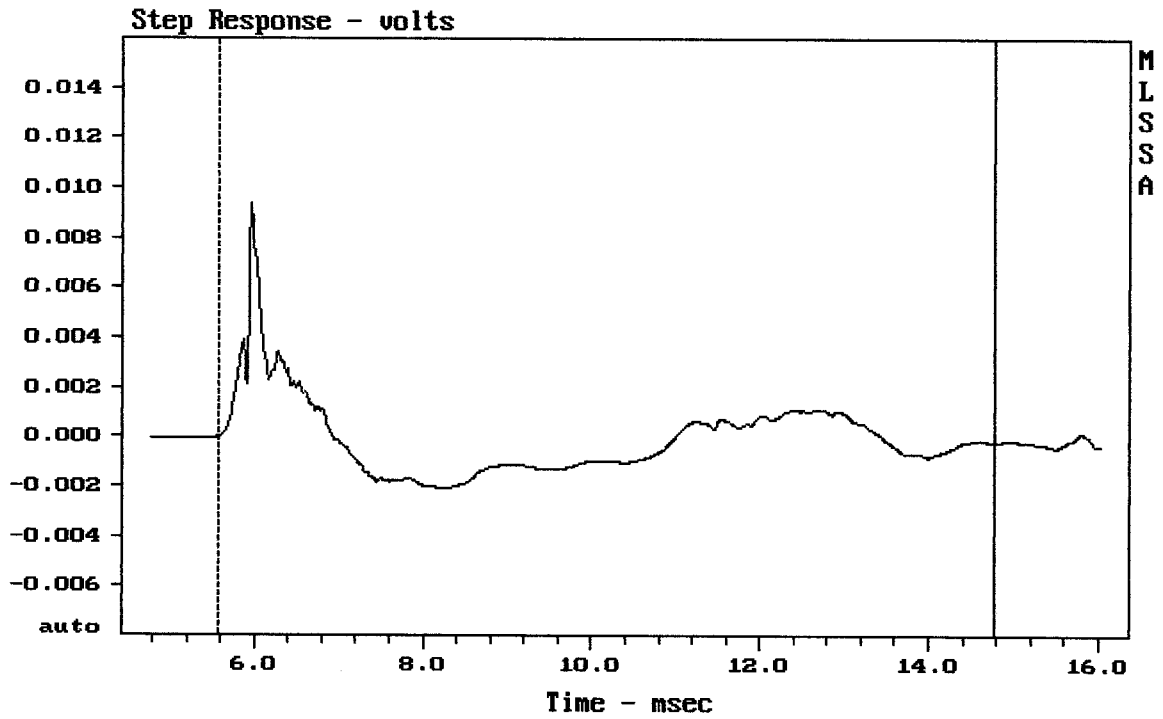

mean: -7.232×10^{-5} , rms: 0.001572, std: 0.001571, max: 0.009355, min: -0.002092

15HPL76 + DE250 + A7570

MLSSA: Time Domain

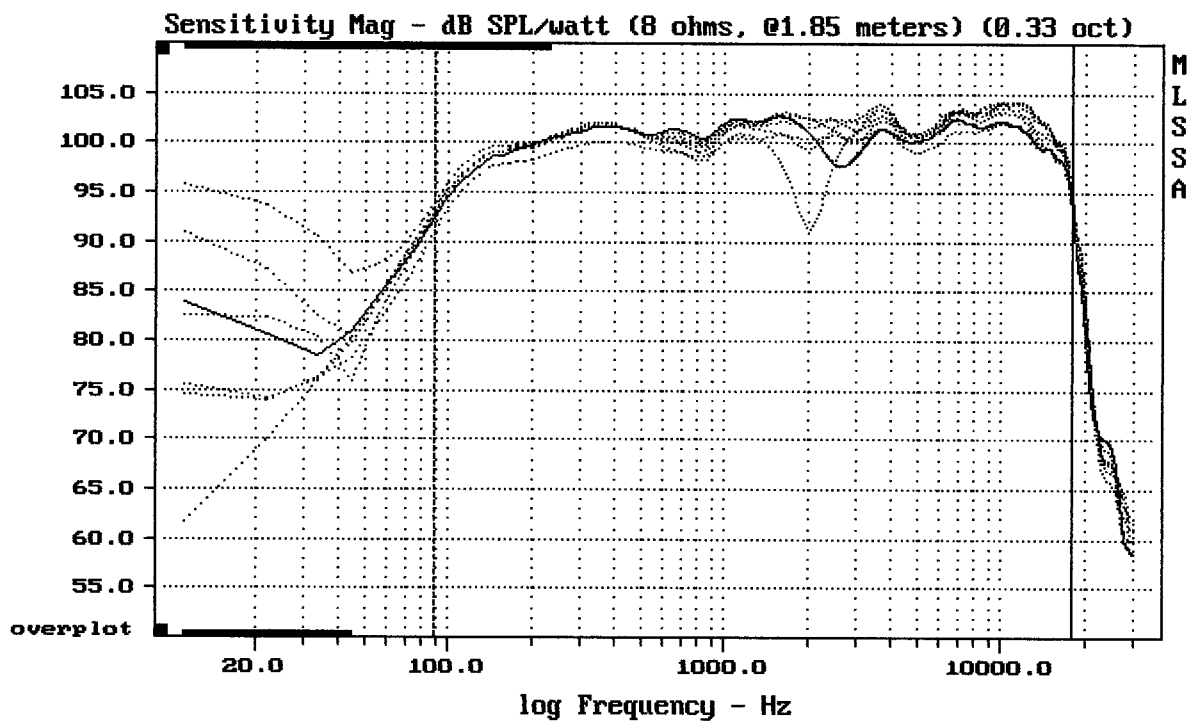

mean: 101.79, rms: 102.05, std: 1.95, max: 104.21, min: 91.37

15HPL76 + DE250 + A7570

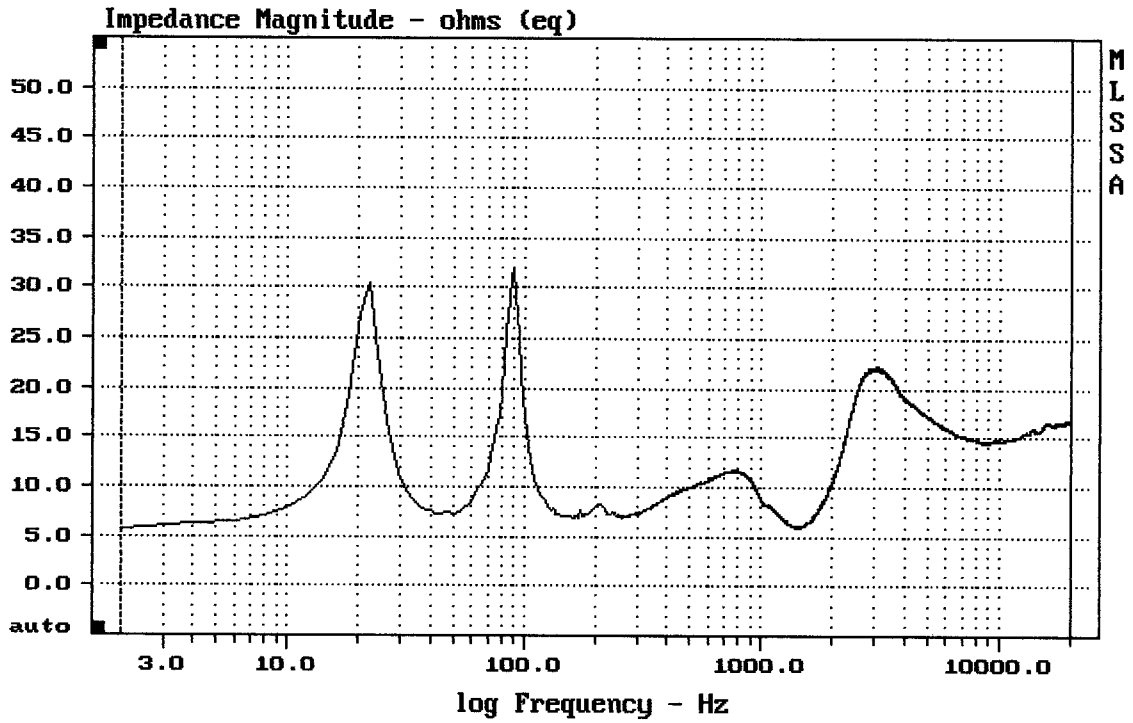

15HPL76 + DE250 + A7570

MLSSA: Frequency Domain

