

Sestava B&C Speakers 15PWB40 + DE610 + Megaton B8575

Osazení:

- B&C Speakers 15PWB40 8/Ohm
<http://eshop.prodance.cz/DetailPage.asp?DPG=82917>
- B&C Speakers DE610 8/Ohm
<http://eshop.prodance.cz/DetailPage.asp?DPG=82315>
- Megaton B8575
<http://eshop.prodance.cz/DetailPage.asp?DPG=84261>

Schéma výhybky:

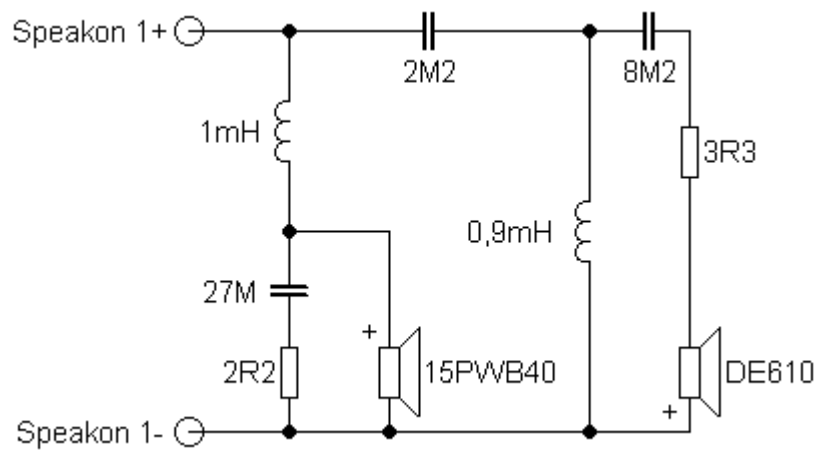

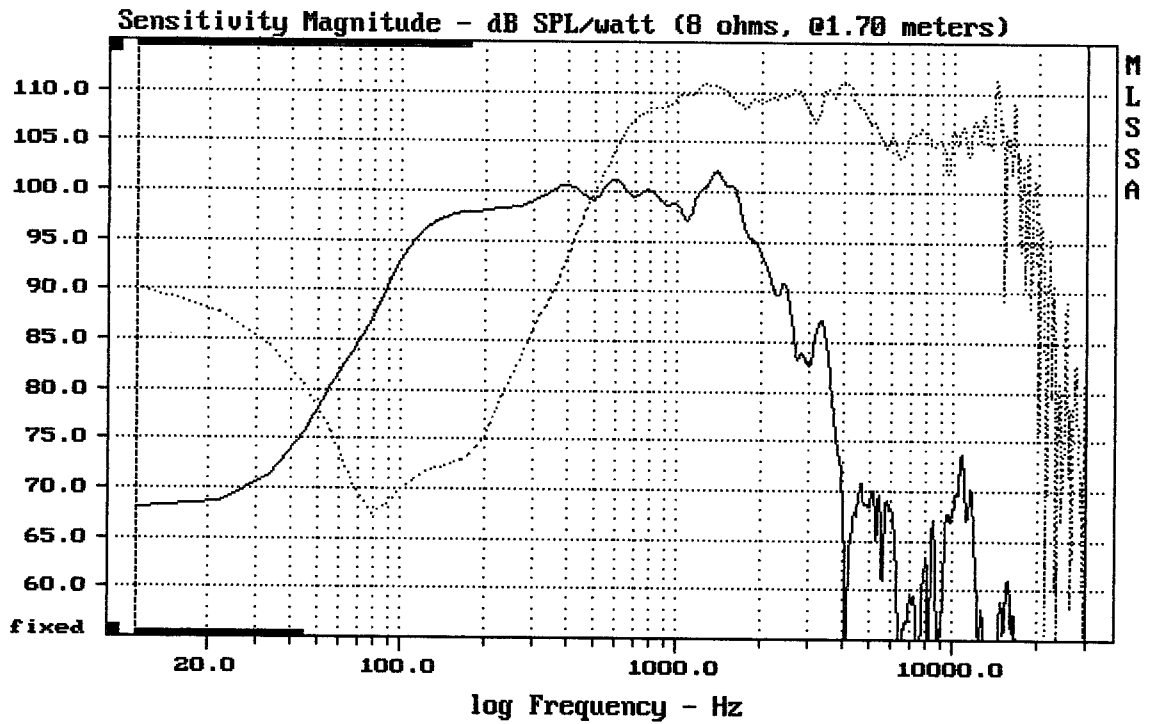

15PWB40 + DE610 + B8575

MLSSA: Frequency Domain

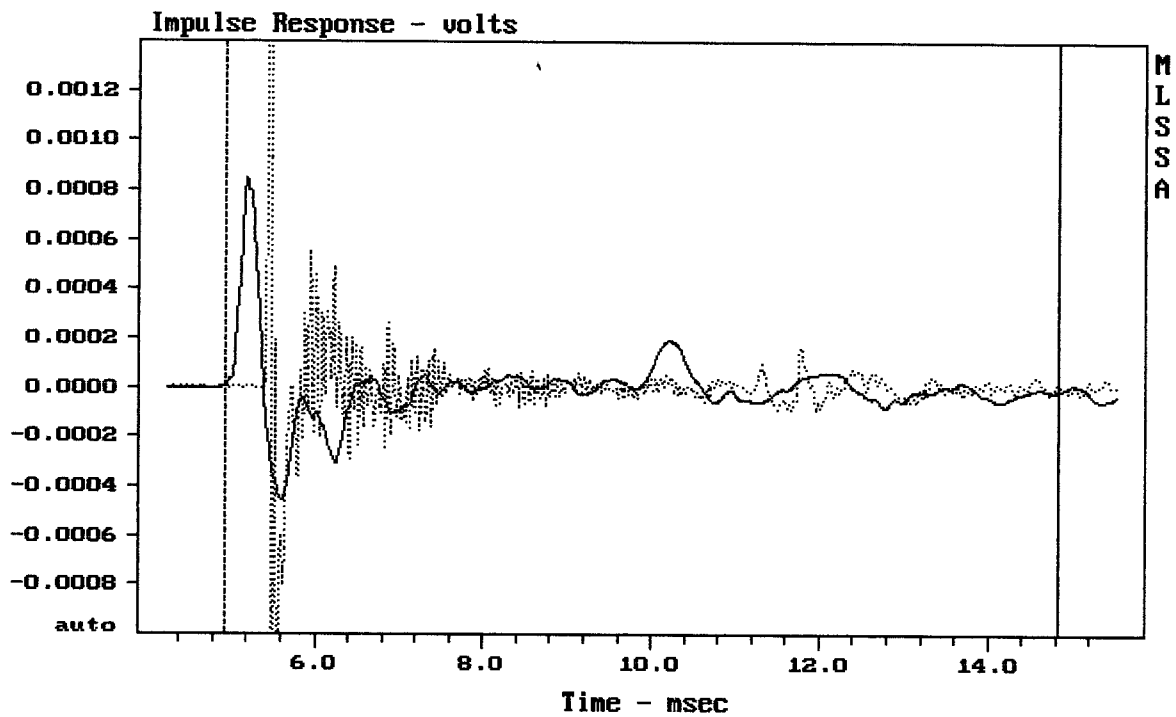

15PWB40 + DE610 + B8575

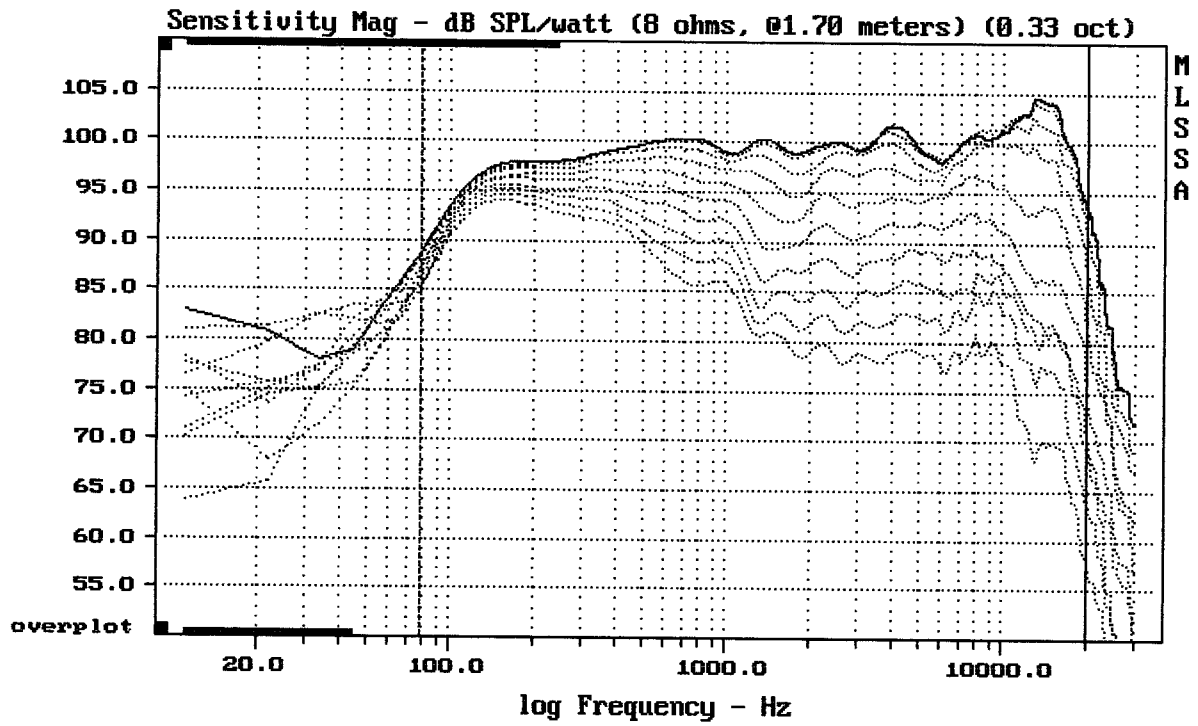

Overlay Compare: dev= +23/-10, std= 7.3, avg= -26

15PWB40 + DE610 + B8575

MLSSA: Frequency Domain

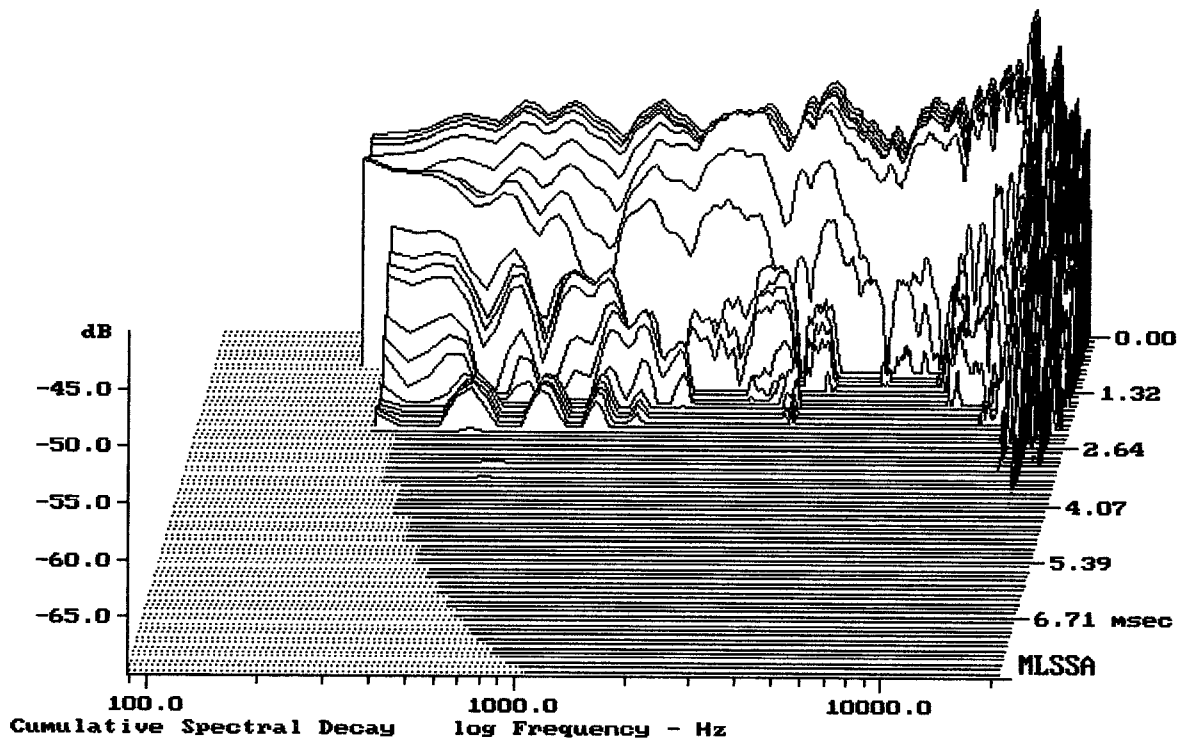

-68.76 dB, 3640 Hz (82), 2.090 msec (20)

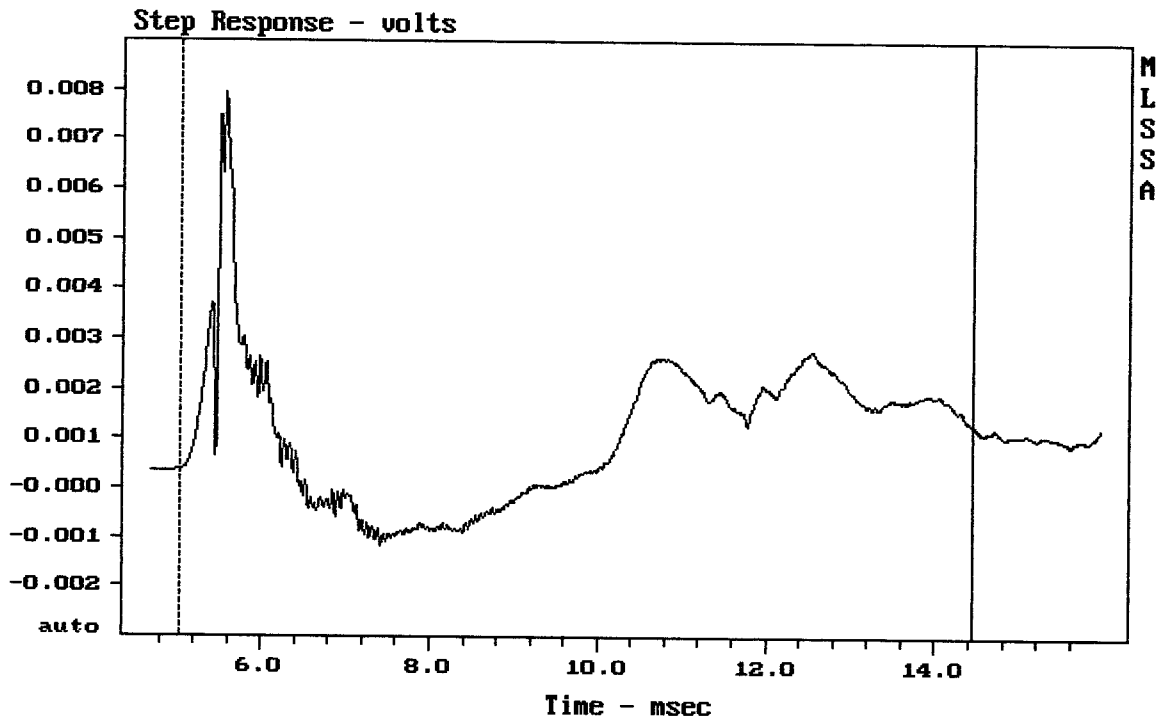

mean: 0.001111, rms: 0.001844, std: 0.001472, max: 0.007946, min: -0.00116

15PWB40 + DE610 + B8575

MLSSA: Time Domain

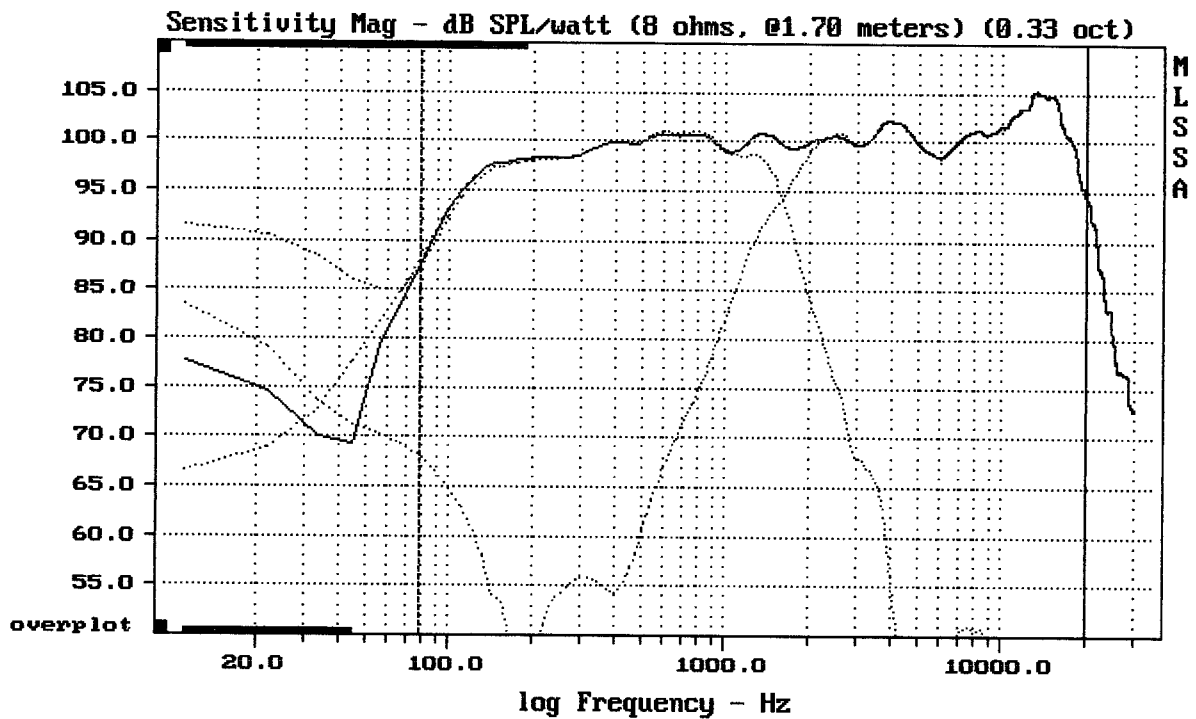

Level (78:20000 Hz) = 100.07 dB SPL/watt (8 ohms, @1.70 meters) (0.33 oct)

15PWB40 + DE610 + B8575

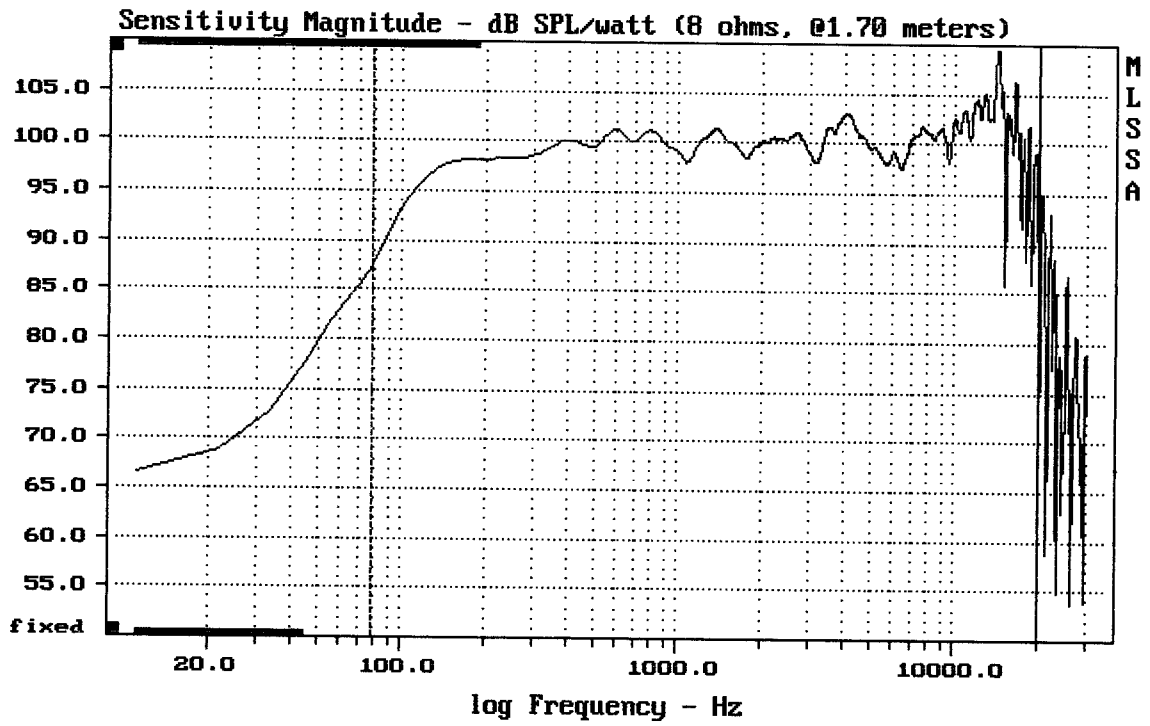

mean: 101.12, rms: 101.71, std: 2.80, max: 109.43, min: 85.88

15PWB40 + DE610 + B8575

MLSSA: Frequency Domain

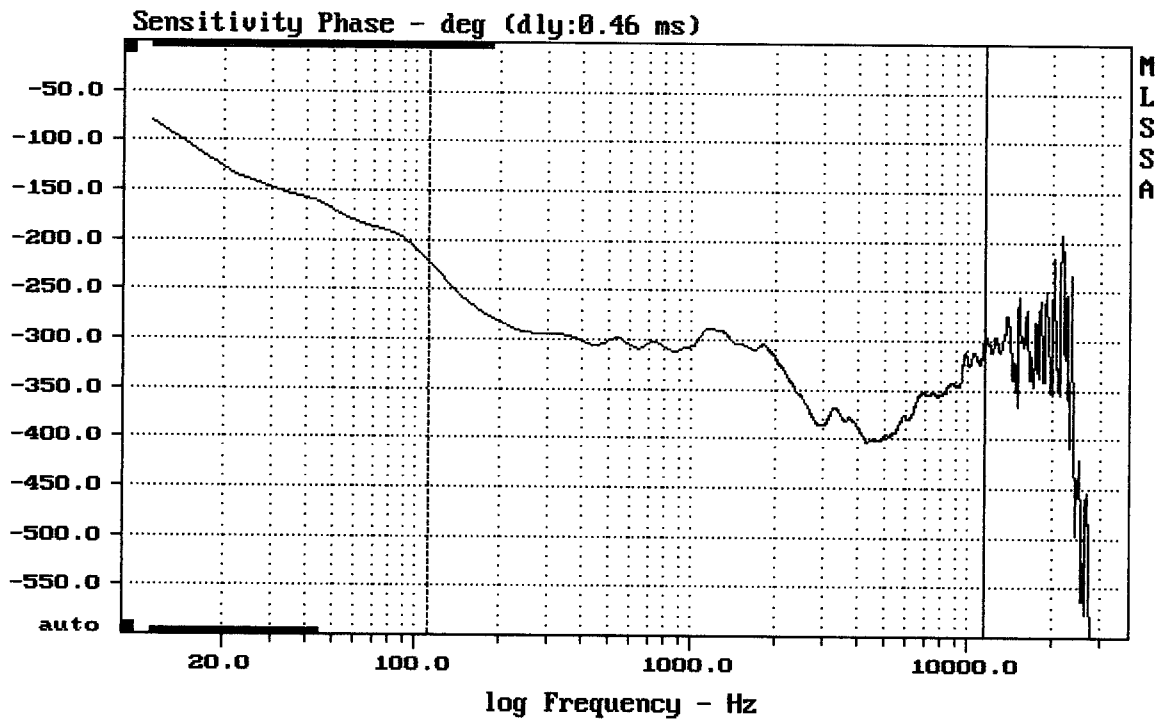

mean: -348.2, rms: 349.8, std: 33.68, max: -222.1, min: -402.9

15PWB40 + DE610 + B8575

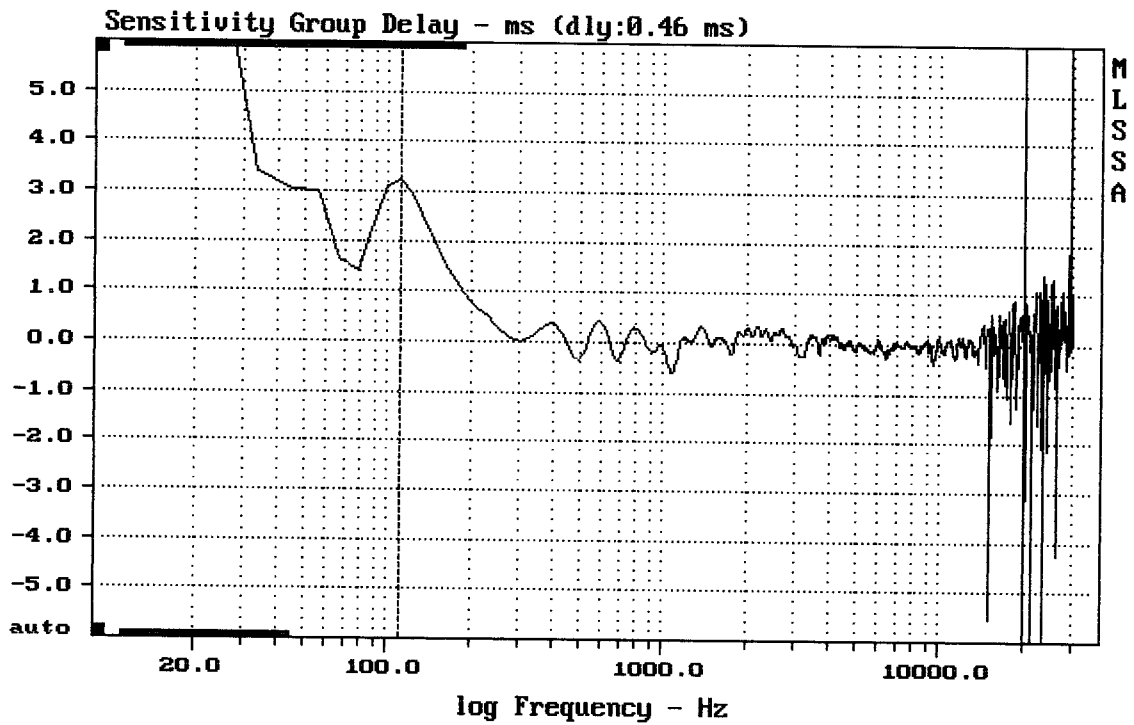

mean: 0.01222, rms: 0.4096, std: 0.4094, max: 3.216, min: -5.516

15PWB40 + DE610 + B8575

MLSSA: Frequency Domain

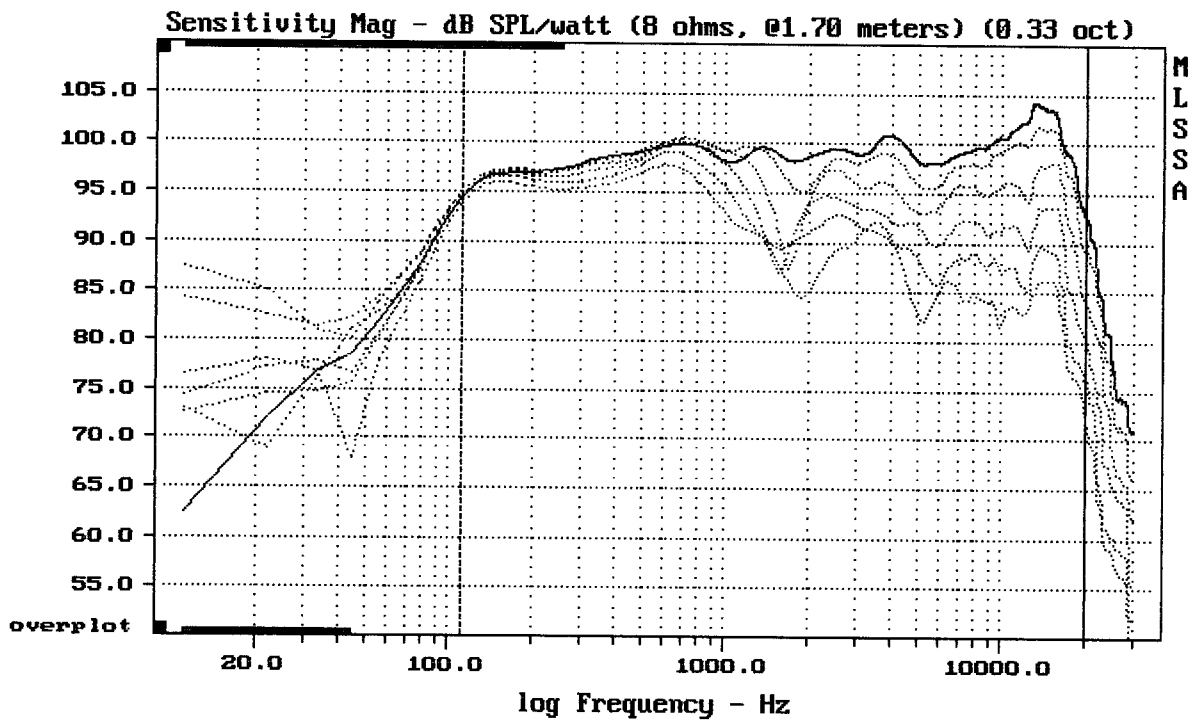

Overlay Compare: dev= +15/-6.3, std= 4.5, avg= -16

15PWB40 + DE610 + B8575

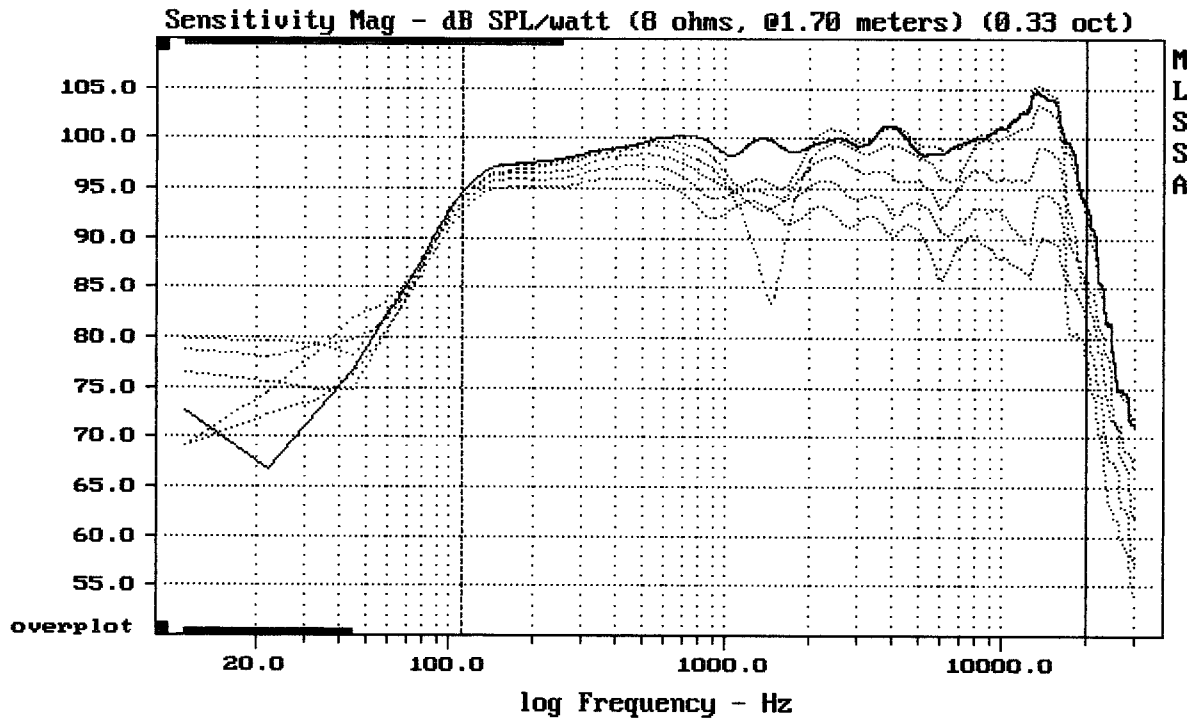

Overlay Compare: dev= +10/-6.6, std= 3.7, avg= -12

15PWB40 + DE610 + B8575

MLSSA: Frequency Domain

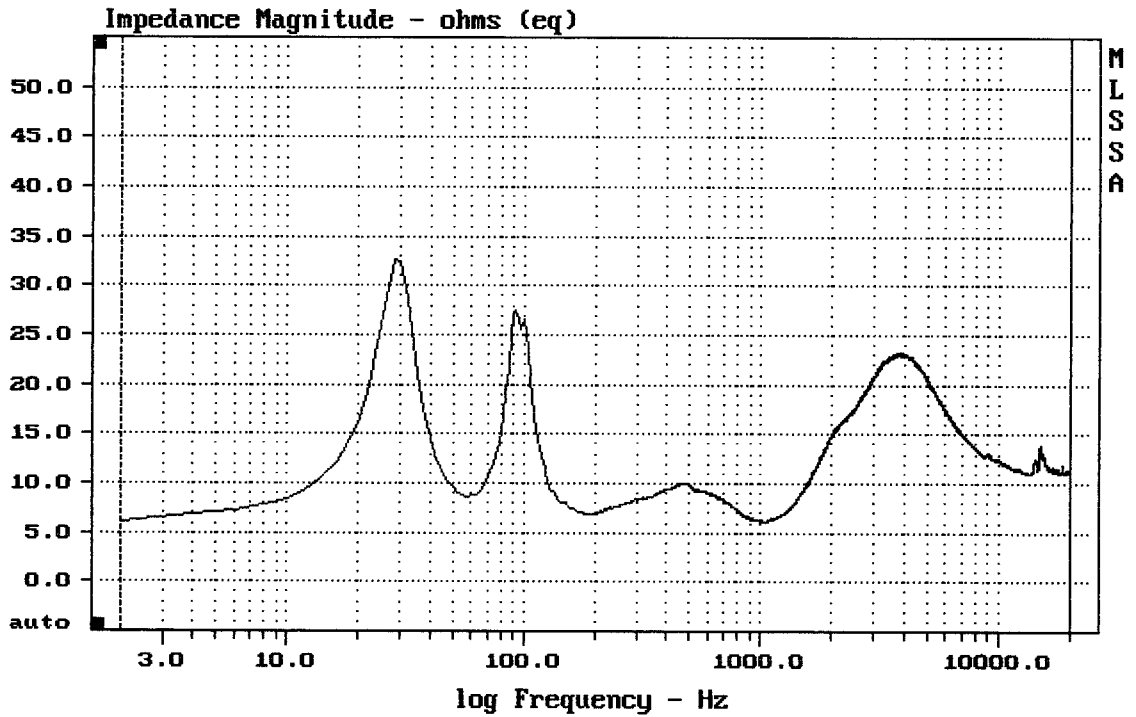

mean: 13.6, rms: 14.16, std: 3.937, max: 32.59, min: 6.109

15PWB40 + DE610 + B8575