

Sestava B&C Speakers 15NW76 + RCF ND3030T3 + DAS Audio BP-91

Osazení:

- B&C Speakers 15NW76 8/Ohm
<http://eshop.prodance.cz/DetailPage.asp?DPG=82866>
- RCF ND3030T3 8/Ohm
<http://eshop.prodance.cz/DetailPage.asp?DPG=79637>
- DAS Audio BP-91
<http://eshop.prodance.cz/DetailPage.asp?DPG=84394>

Schéma výhybky:

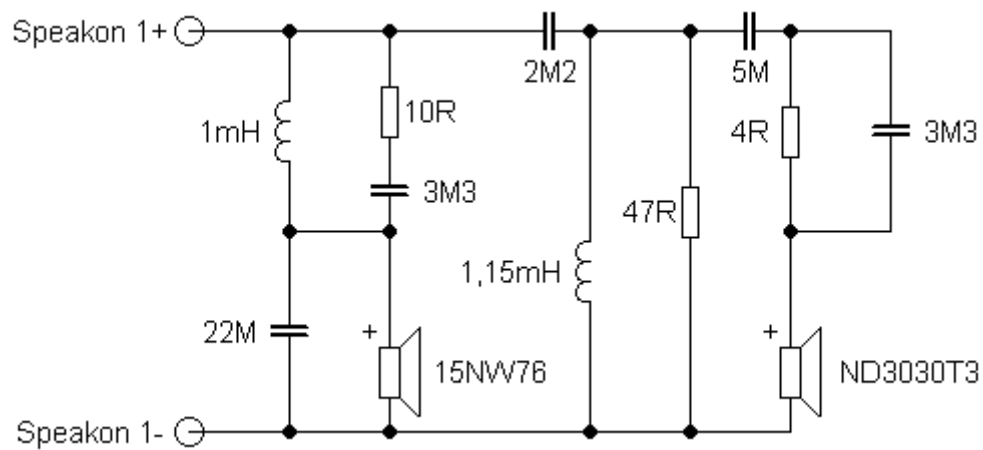

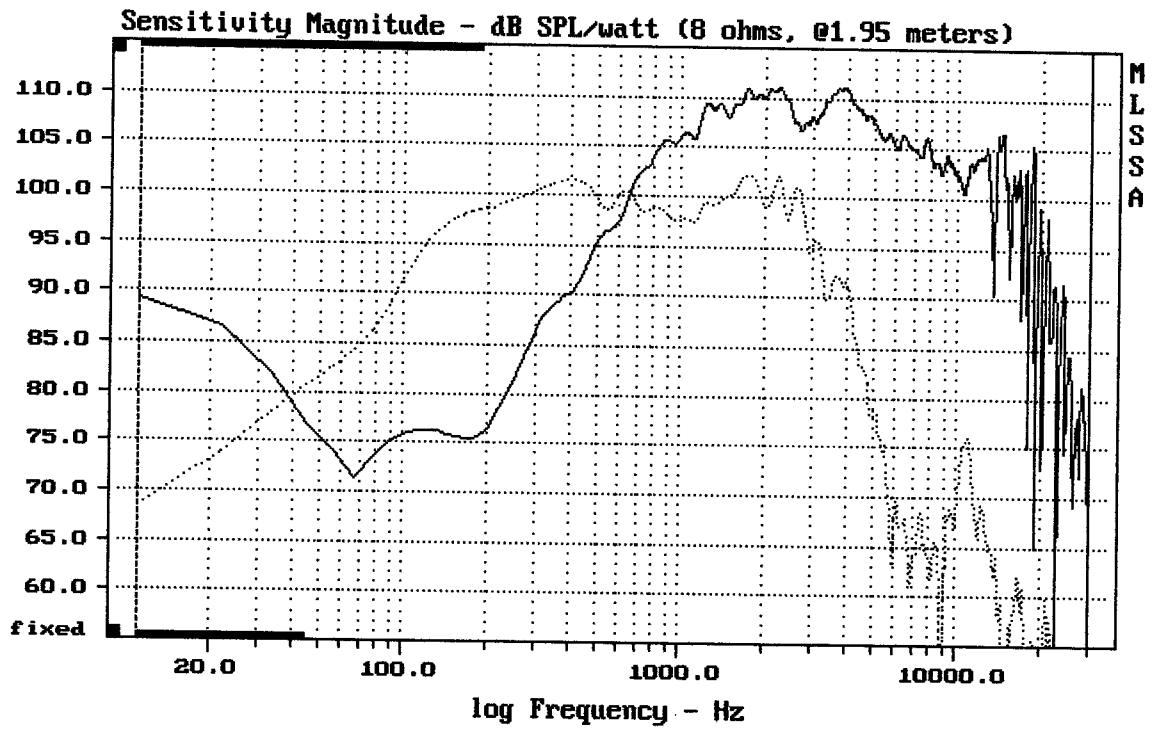

CURSOR: dy = -37.4954 x = 30007.1014 (2704)

15NW76 + ND3030T3 + BP91

MLSSA: Frequency Domain

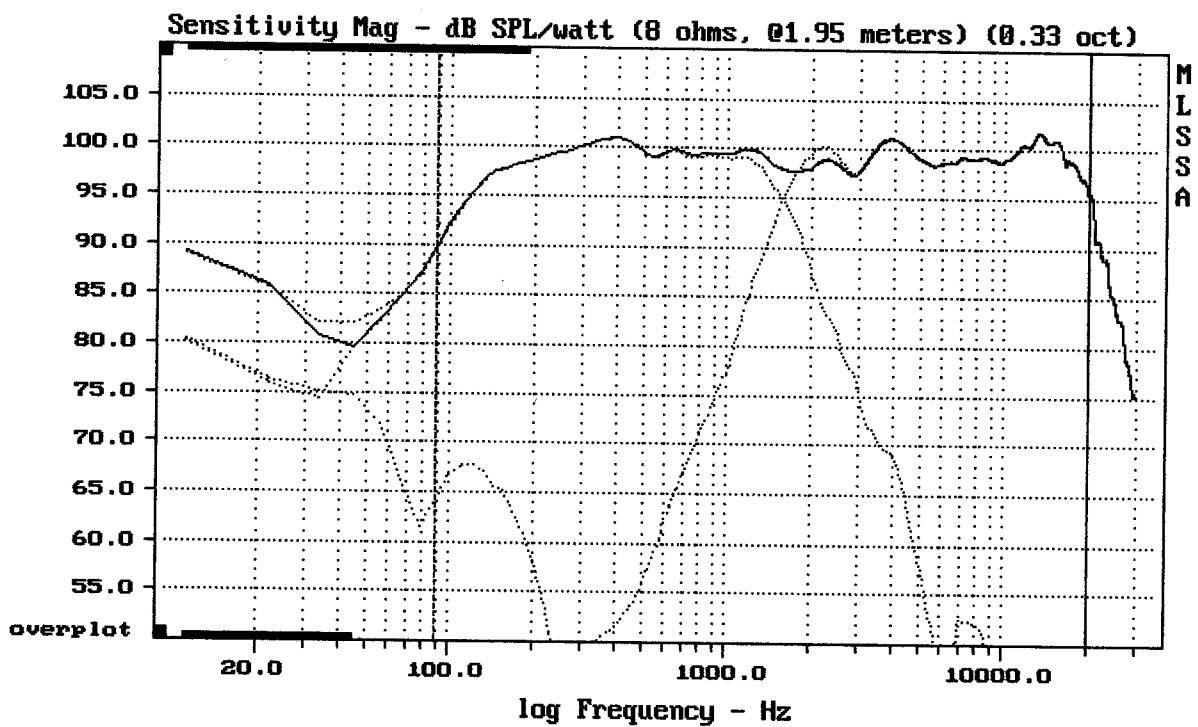

Level (89:20000 Hz) = 99.11 dB SPL/watt (8 ohms, @1.95 meters) (0.33 oct)

15NW76 + ND3030T3 + BP91

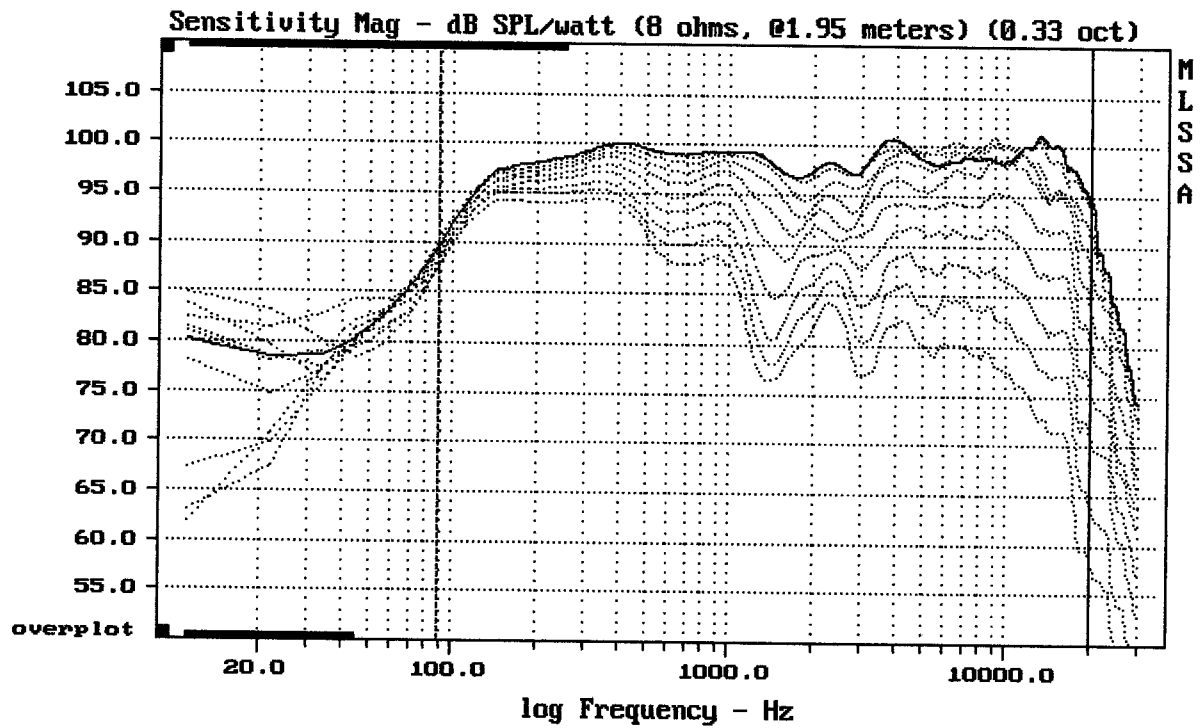

Overlay Compare: dev= +21/-13, std= 7, avg= -23

15NW76 + ND3030T3 + BP91

MLSSA: Frequency Domain

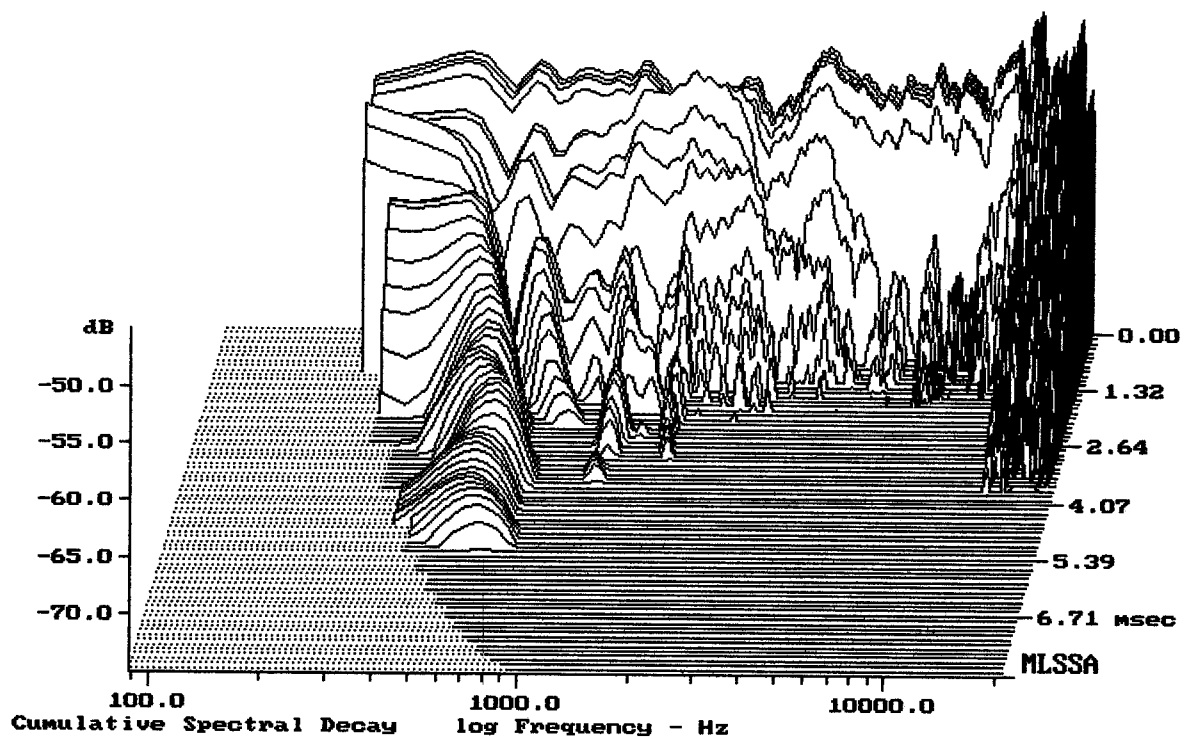

-73.81 dB, 1776 Hz (40), 2.860 msec (27)

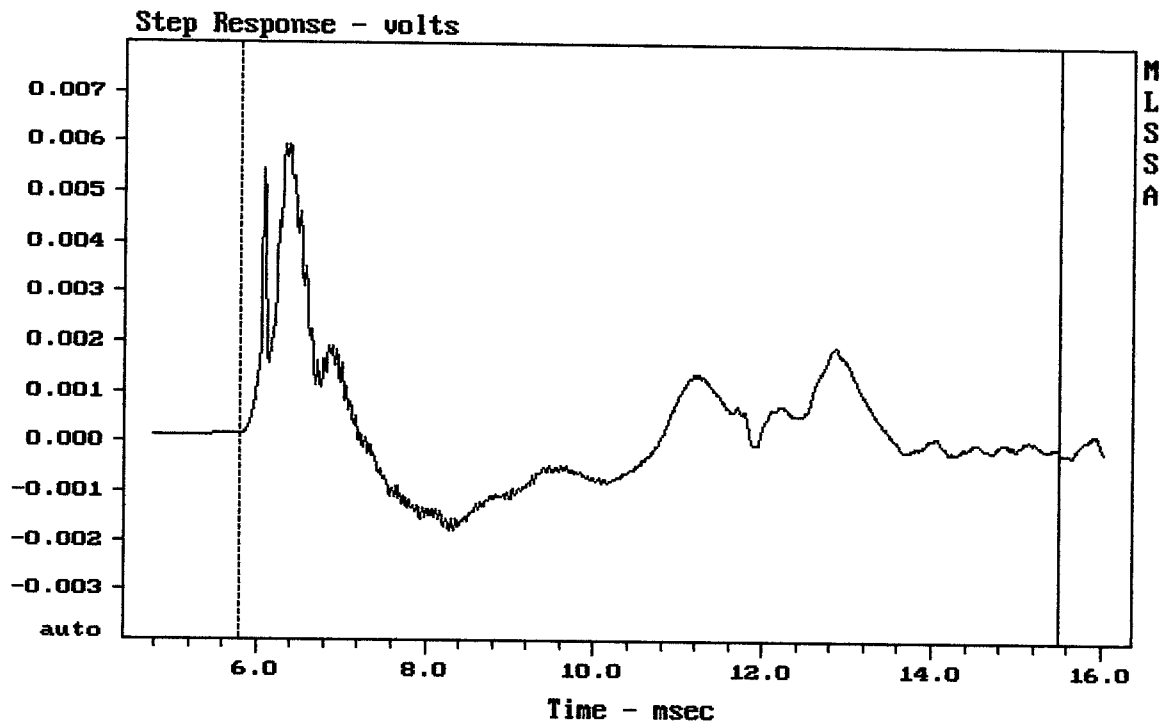

mean: 0.000244, rms: 0.001344, std: 0.001322, max: 0.005941, min: -0.001793

15NW76 + ND3030T3 + BP91

MLSSA: Time Domain

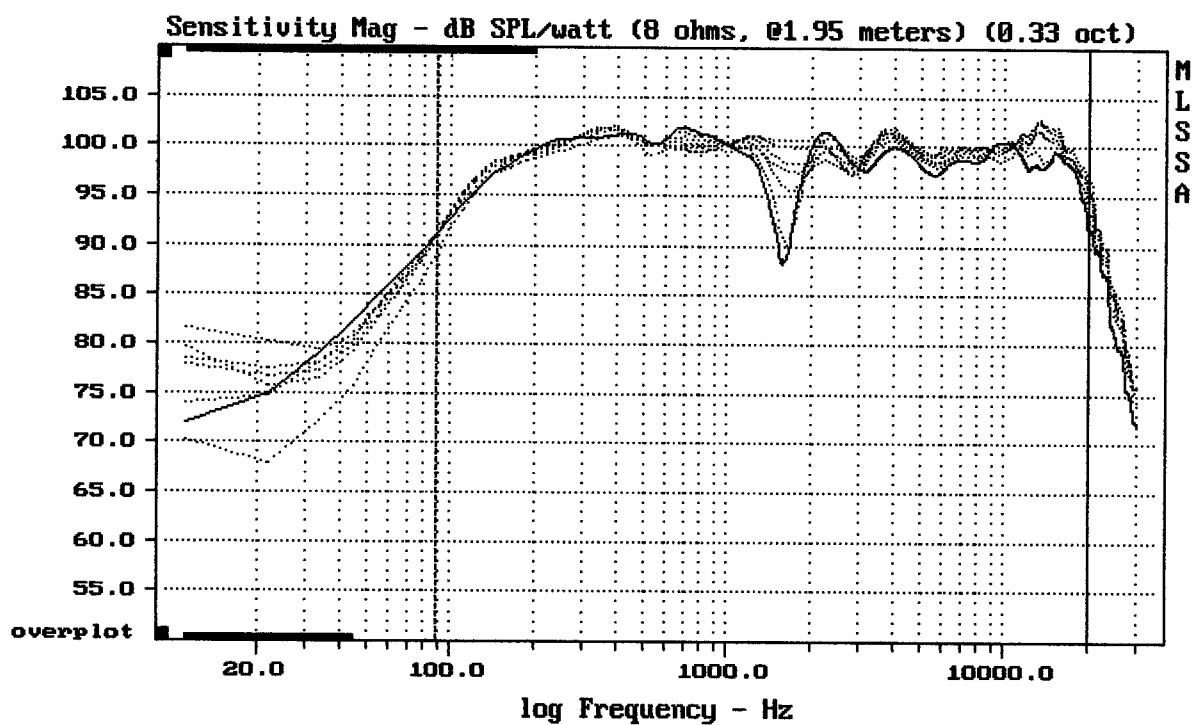

mean: 100.20, rms: 100.30, std: 1.21, max: 102.61, min: 91.19

15NW76 + ND3030T3 + BP91

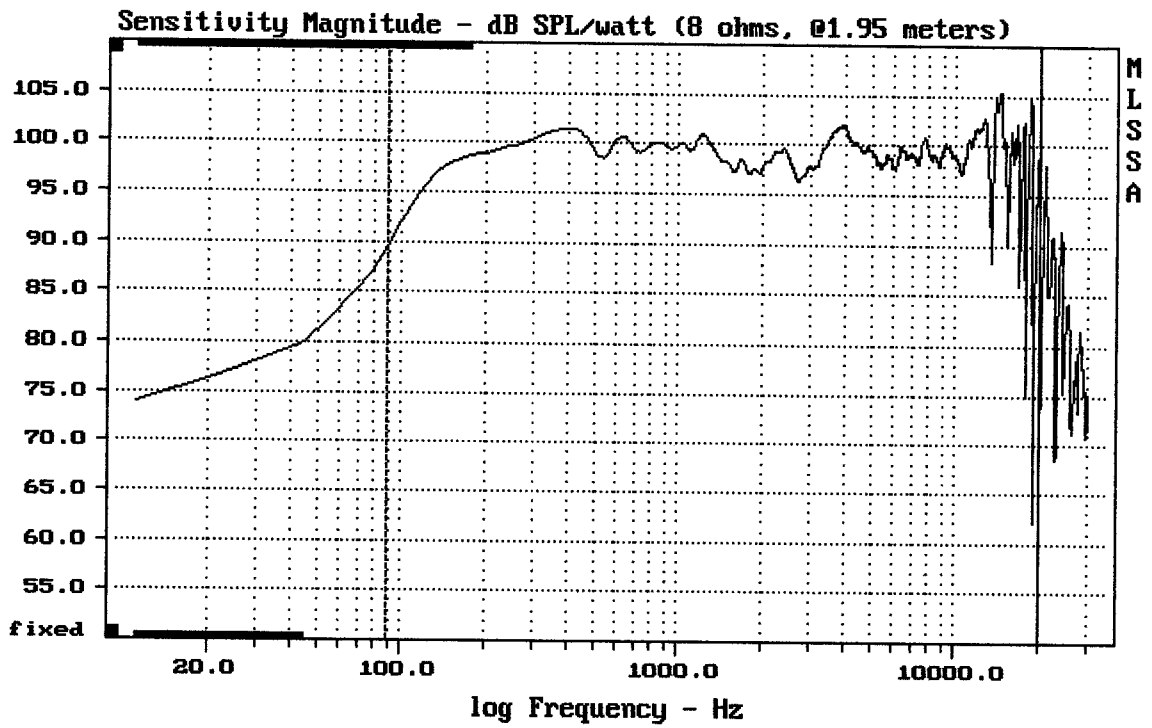

mean: 99.26, rms: 99.71, std: 2.48, max: 105.37, min: 62.04

15NW76 + ND3030T3 + BP91

MLSSA: Frequency Domain

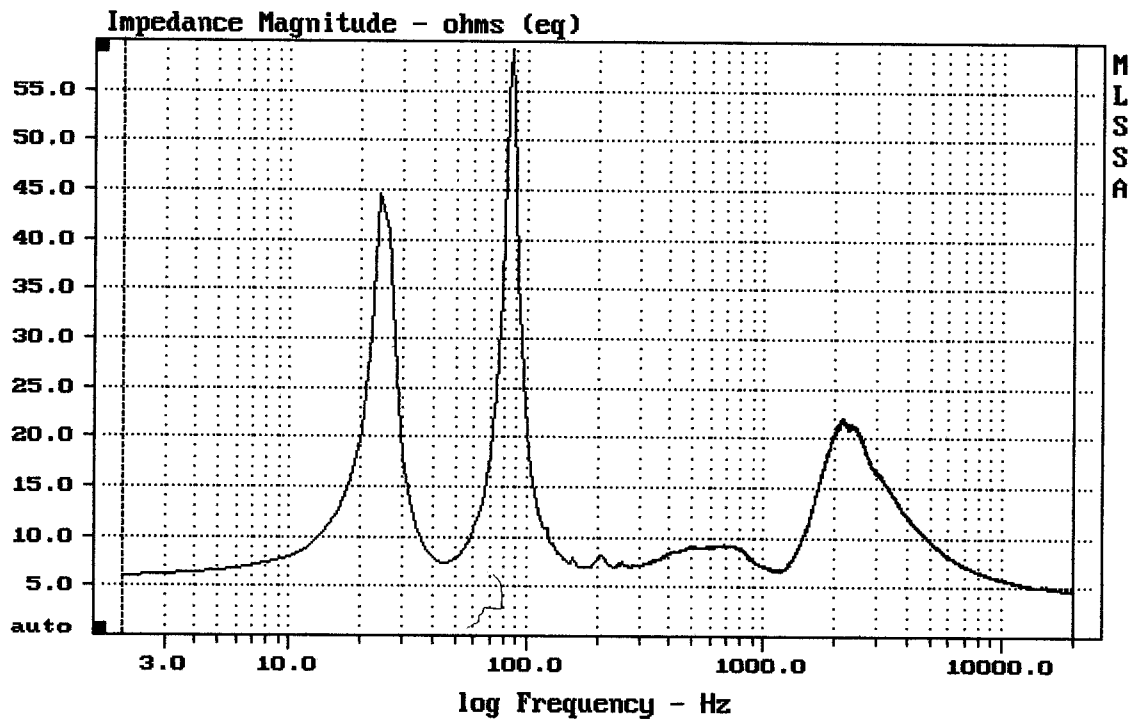

mean: 7.658, rms: 8.749, std: 4.231, max: 59.3, min: 4.646

15NW76 + ND3030T3 + BP91