

Sestava RCF MB15H401 + B&C Speakers DE610 + ME90

Osazení:

- RCF MB15H401 8/Ohm

<http://eshop.prodance.cz/DetailPage.asp?DPG=87624>

- B&C Speakers DE610 8/Ohm

<http://eshop.prodance.cz/DetailPage.asp?DPG=82315>

- B&C Speakers ME90

<http://eshop.prodance.cz/DetailPage.asp?DPG=80246>

Schéma výhybky:

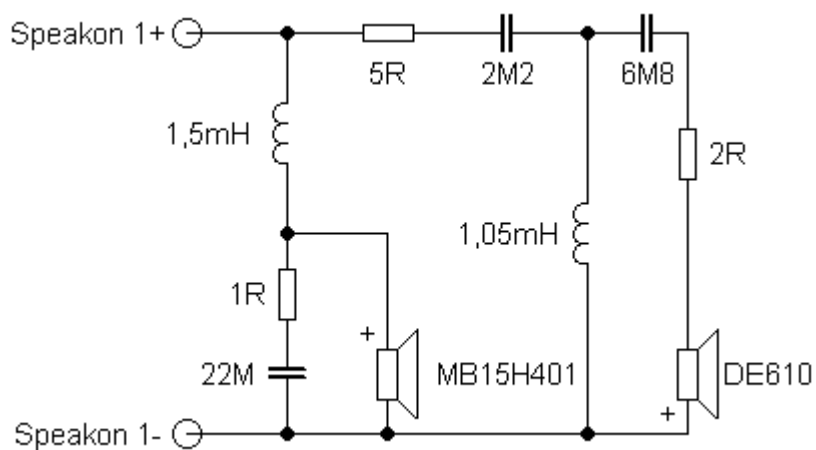

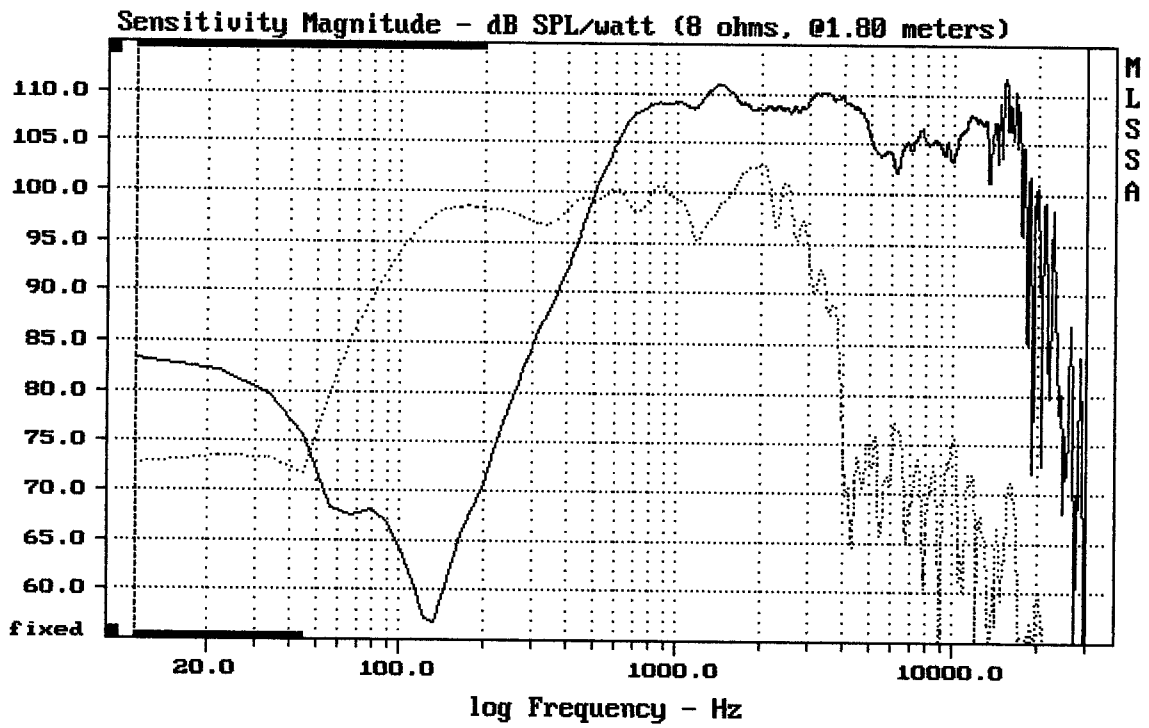

CURSOR: $dy = -35.9747$ $x = 30007.1014$ (2704)

MB15H401 + DE610 + ME90

MLSSA: Frequency Domain

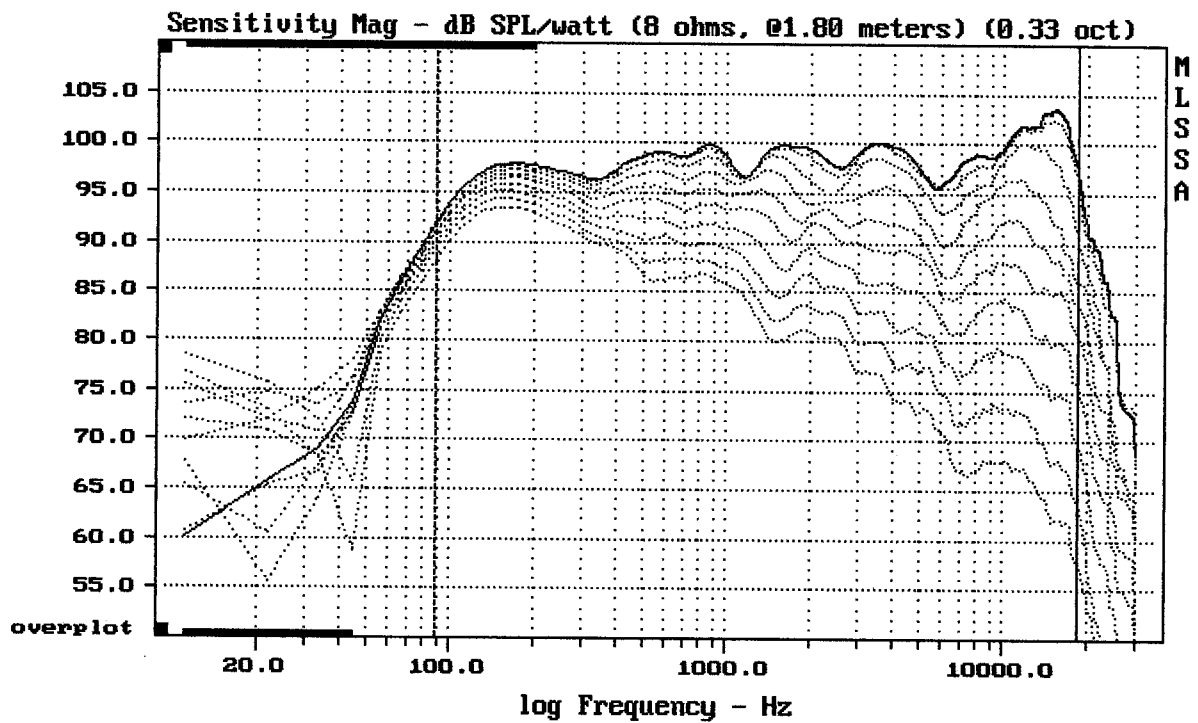

Overlay Compare: $dev = +27/-11$, $std = 8.8$, $avg = -30$

MB15H401 + DE610 + ME90

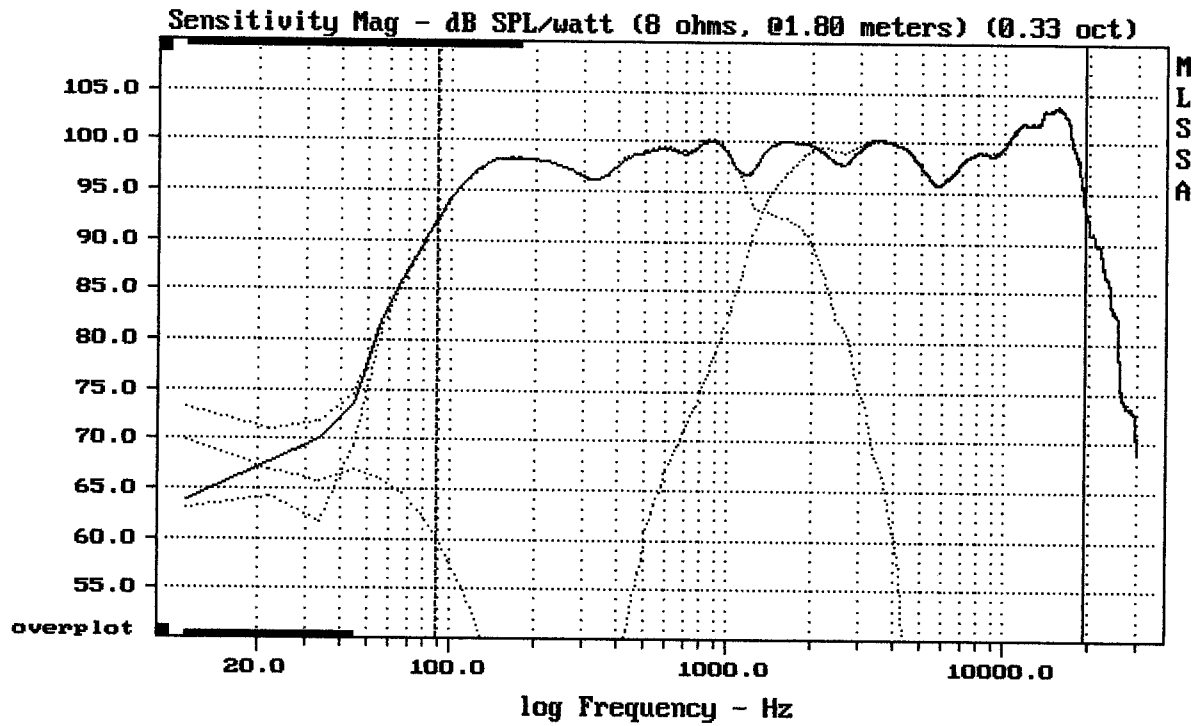

Level (89:19509 Hz) = 98.95 dB SPL/watt (8 ohms, @1.80 meters) (0.33 oct)

MB15H401 + DE610 + ME90

MLSSA: Frequency Domain

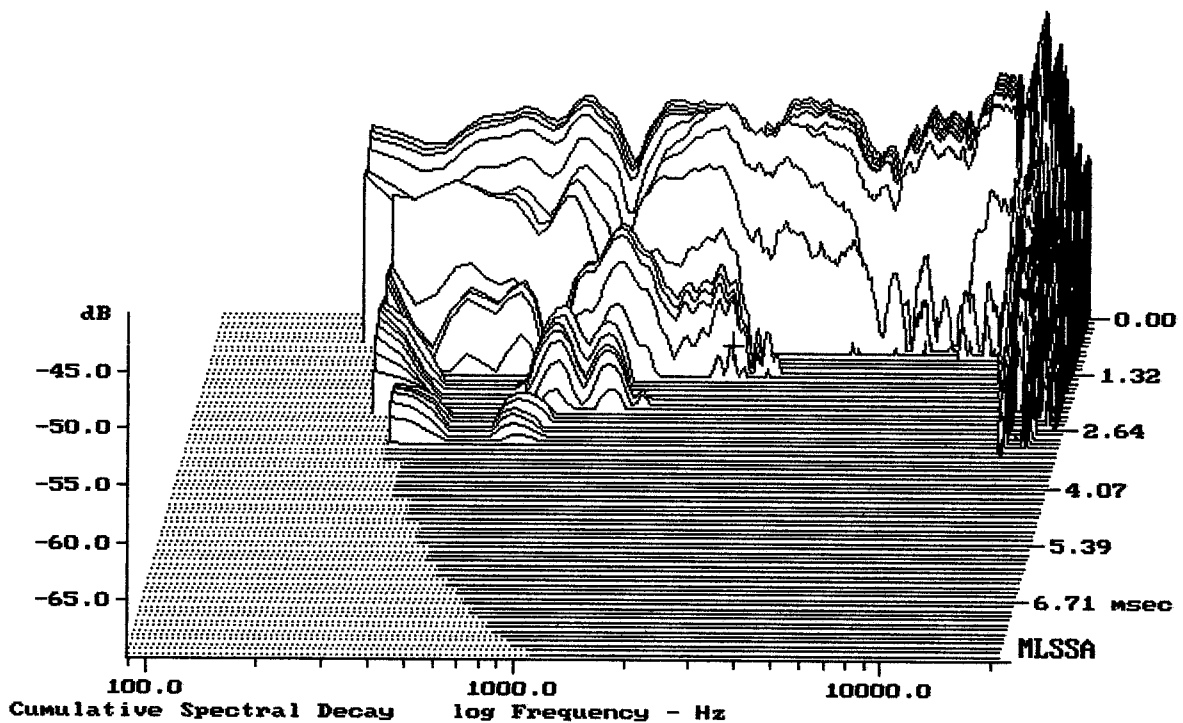

-67.19 dB, 2397 Hz (54), 1.430 msec (14)

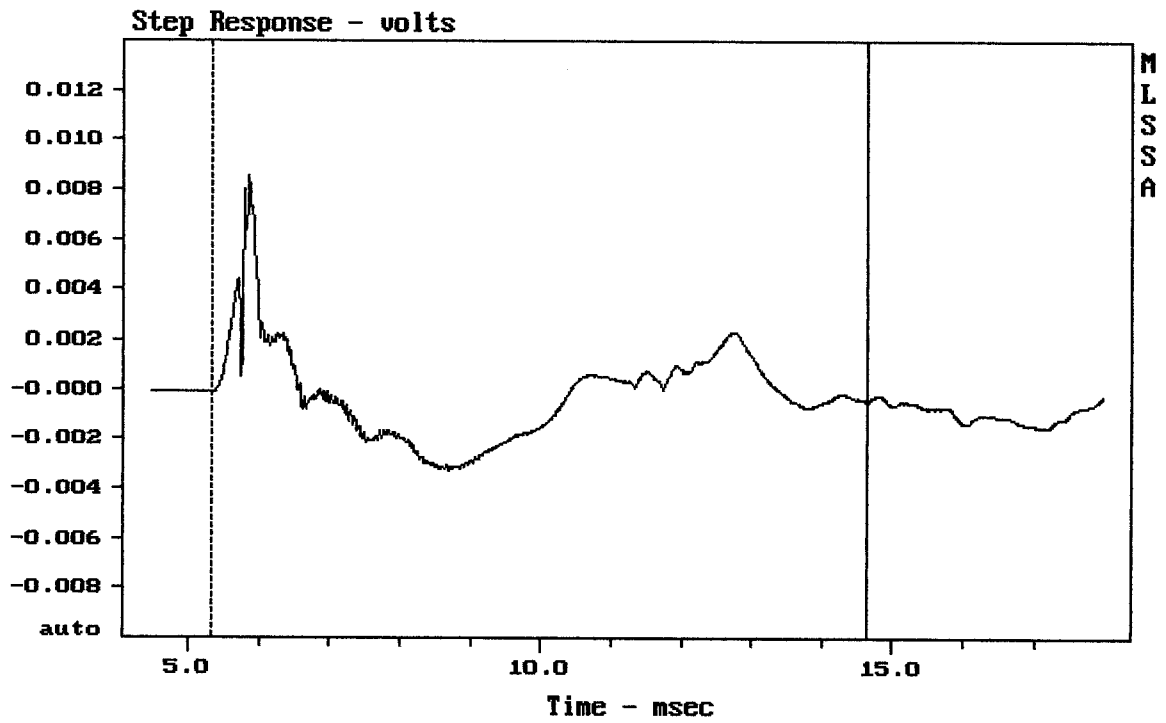

mean: -0.0002054, rms: 0.001895, std: 0.001884, max: 0.008567, min: -0.003294

MB15H401 + DE610 + ME90

MLSSA: Time Domain

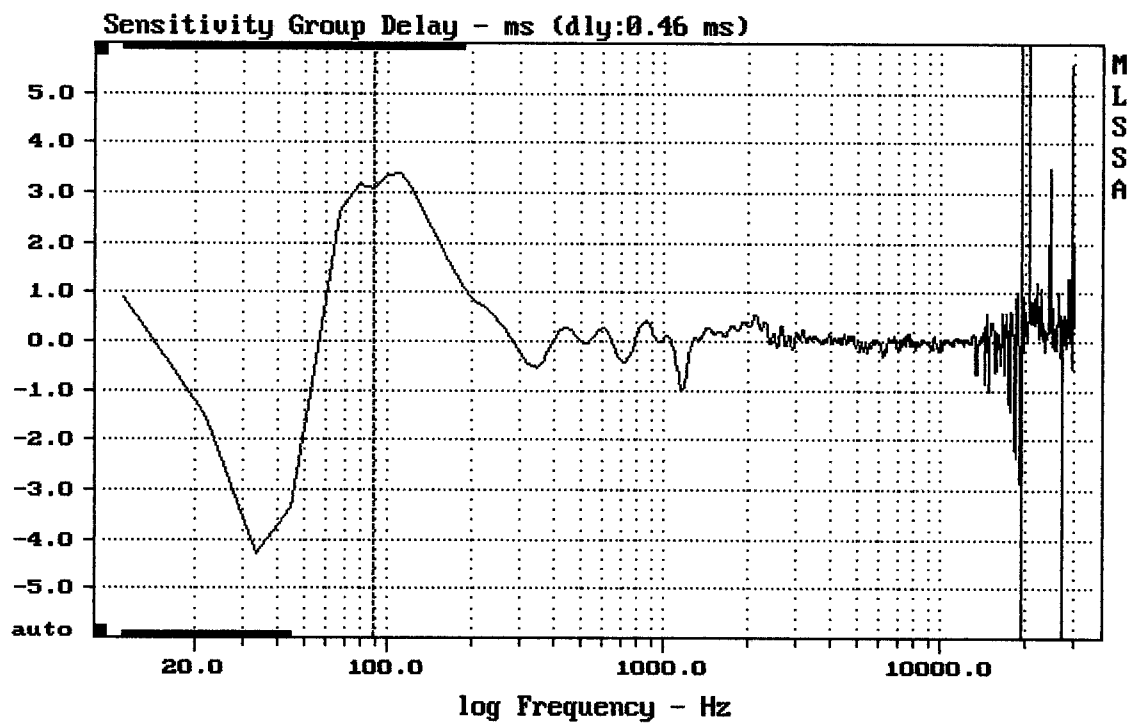

mean: 0.008149, rms: 0.4227, std: 0.4226, max: 3.377, min: -2.836

MB15H401 + DE610 + ME90

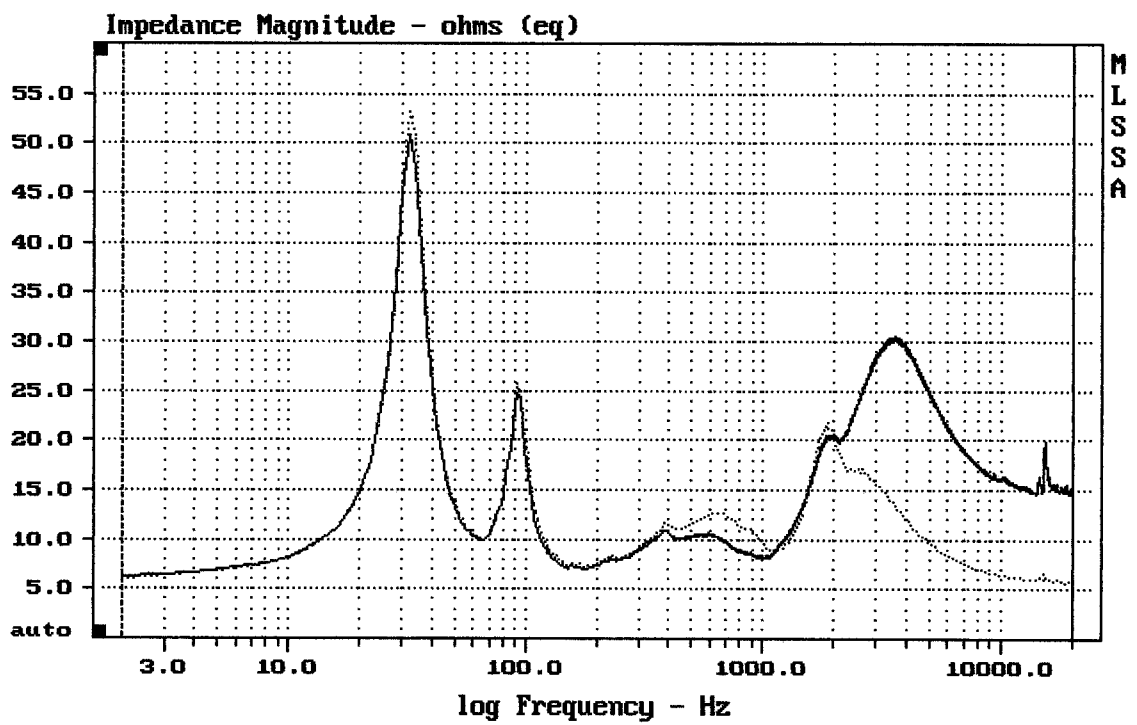

mean: 8.296, rms: 9.069, std: 3.663, max: 53.22, min: 5.7

MB15H401 + DE610 + ME90